

Solutions Beyond Expectations

كتالوج Catalog 2024



AMMON
Imad Sweis Bros. Co.





- مقدمة Introduction
- تاريخنا Our History
- الرؤية والرسالة Mission And Vision
- قيمنا Values
- كتالوج المنتجات Product Catalog



تأسست شركة **عماد صويس واخوانه (عمون للصناعات البلاستيكية)** في العام 1993 امتدادا لخبراتنا منذ عام 1975 كمصنع صغير متخصص في صناعة الأدوات البلاستيكية. بدأت رحلتنا مع آلة حقن صغيرة وزادت شهرتنا يومًا بعد يوم حتى أصبحنا اليوم من الرواد في الأردن والشرق الأوسط. تطورت منتجاتنا لتشمل تشكيلة واسعة من الاصناف المخصصة للتعبئة والتغليف، مواكبةً للتغيرات والتطورات في السوق واحتياجات العملاء.

اليوم، نفتخر بأن "**عمون**" ليست مجرد اسم، بل هو رمز للجودة والخدمة الممتازة. تقع جذورنا في قلب عمان، ولكن رؤيتنا تمتد إلى الأفق، حيث نسعى لتقديم حلول تعبئة وتغليف تجمع بين التراث والابتكار.

Established in 1993, **Ammon (Imad Sweis & Bros. Co)** began its journey as a modest facility specializing in single-use plastic utensils as an extension of our experience since 1975. From our humble beginnings with a singular injection molding machine, our reputation grew day by day, positioning us today as industry leaders in Jordan and the Middle East. Our product range has evolved to encompass a broad array of one-time use packaging, aligning with market shifts and customer needs.

Today, "**Ammon**" is not just a name – it stands as a symbol of exceptional quality and service. Rooted in the heart of Amman, our vision extends beyond, as we strive to deliver packaging solutions that bridge heritage with innovation.



في عام 1993، نشأت فكرة عمون في قلب عمان، الأردن. بدأت كمصنع صغير متخصص في الأدوات البلاستيكية القابلة للاستخدام مرة واحدة، وقد كانت البداية مع آلة حقن صغيرة. ومع مرور الوقت، ازدادت أعمالنا وأصبحت تغطي مناطق أوسع في الأردن والشرق الأوسط. مع كل مرحلة نمو، كان هناك التزام ثابت بالجودة والابتكار. اليوم، تفخر عمون بأن تكون واحدة من أبرز الشركات في مجال توفير حلول العبوات المستدامة في العالم.

In 1993, the idea of Ammon was born in the heart of Amman, Jordan. Starting as a modest facility specializing in single-use plastic utensils, our inception was marked with a singular injection molding machine. As time progressed, our operations expanded, reaching broader territories within Jordan and the Middle East. With each growth phase, there remained a steadfast commitment to quality and innovation. Today, Ammon takes pride in being among the foremost companies in the realm of sustainable packaging solutions in the world.



رؤيتنا ورسالتنا

Vision & Mission



رسالتنا:

نلتزم بتقديم منتجات وحلول عالية الجودة تلبى احتياجات العملاء، نؤمن على الحفاظ على قيمنا المستدامة ودعم المجتمع المحلي. نؤمن بتقديم الجودة والاستدامة ضمن أفضل المعايير ونعمل جاهدين لجعل حياة عملائنا أسهل وأكثر خضرة وبناء شراكة معهم.

Our Mission:

We are committed to providing high-quality products and solutions that meet customer needs. We believe in maintaining our sustainable values and supporting the local community. We believe in providing quality and sustainability within the best standards and we work hard to make our customers' lives easier and greener and build a partnership with them.



رؤيتنا:

نسعى في "عمون" لأن نكون الرائدة في مجال التعبئة والتغليف في الشرق الأوسط، موازيين بين العمالة الأردنية وأحدث التقنيات العالمية.

Our Vision:

At Ammon, we aspire to be the frontrunners in packaging solutions in the Middle East, striking a balance between Jordan's rich workforce and the latest global technologies.

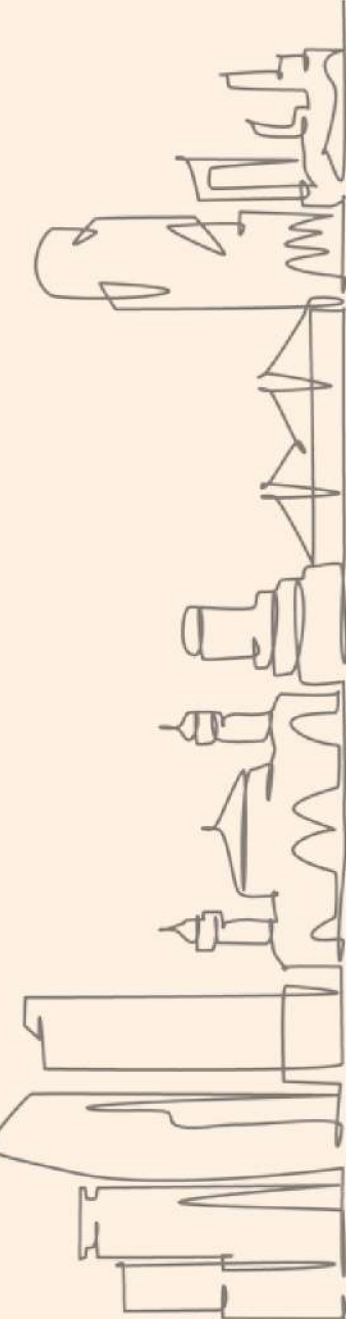



إعادة التدوير

نتبنى الممارسات التي تحافظ على الموارد الطبيعية للأجيال القادمة، مدركين مسؤوليتنا تجاه كوكبنا.



Zero Waste

We embrace practices that conserve natural resources for future generations, recognizing our responsibility towards our planet.

الابتكار

نبحث باستمرار عن طرق جديدة لتحسين منتجاتنا وخدماتنا، معتمدين على التكنولوجيا والبحث المستمر.



Innovation

We continuously seek new ways to enhance our products and services, relying on cutting-edge technology and ongoing research.

التقاليد

نحن فخورون بجذورنا الأردنية، ونعمل على الحفاظ على تراثنا والجودة العالية في كل ما نقوم به.



Tradition

We take pride in our Jordanian roots and strive to uphold our heritage in everything we do.

الشراكة

نقدر عمق العلاقات التي بنيناها مع شركائنا وعملائنا، ونؤمن بأهمية النجاح المشترك.



Partnership

We value the deep relationships we've built with our partners and clients, believing in the importance of mutual success.

الجودة

لدينا التزام لا هوادة فيه بتقديم المنتجات والخدمات الأفضل لعملائنا.



Quality

We have an unwavering commitment to delivering the best products and services to our customers.

العلاقة الطيبة

النجاح المشترك والعلاقة الطيبة بيننا وبين العملاء تتقدم لدينا وذات أهمية أكبر من الربح



Good relationship

Joint success and the good relationship between us and customers are our priority and are more important than profit

التميز في التصدير: الوصول العالمي لعمون

في شركة عمون للصناعات البلاستيكية، التزامنا بالجودة والابتكار لا يتوقف عند حدود الأردن. رؤيتنا عالمية، ونحن فخورون بتوسيع مجموعتنا الاستثنائية من المنتجات البلاستيكية وحلول التغليف إلى ما هو أبعد من الاردن، مما يشكل علامة فارقة في السوق الدولية.

Export Excellence: Amoun's Global Reach

At Amoun Plastic Industries, our commitment to quality and innovation doesn't stop at the borders of Jordan. Our vision is global, and we are proud to extend our exceptional range of plastic products and packaging solutions well beyond our home country, making a mark in the international market.



كتالوج
Catalog
2024

- 1 PLASTIC CUTLERY & UTENCILS
أدوات مائدة بلاستيكية مستهلكة
- 2 MULTY-PURPOSE CRYSTAL BOXES
علب حلويات شفافه متعددة الإستعمال
- 3 MULTY-PURPOSE CRYSTAL PLATES
صدون حلويات ومقبلات شفافه متعددة الاستخدام
- 4 PLASTIC PARTY PLATES
صدون حفلات مقوية
- 5 CAKE BOARDS
قواعد كيك
- 6 SERVING TRAYS
صواني تقديم الطعام
- 7 ICE - CREAM BOWLS & DESSERT CUPS
علب وكاسات للبوطة والحلويات
- 8 MICROWAVABLE CONTAINERS SERIES
علب المايكرويف
- 9 SUSHI, WAFFLE, APPETIZERS & SWEETS TRAYS WITH LIDS
علب سوشي ووافل ومقبلات وحلويات مع أغطية
- 10 MULTY-PURPOSE PET CONTAINERS SERIES
شفافة متعددة الاستخدام PET علب
- 11 PET CUPS & LIDS SERIES
كاسات وأغطية شفافه
- 12 SAUSE CUPS & LIDS
علب صوص وتتبيلة ومايونيز
- 13 STARWS
الشالمونات - مصاص العصير
- 14 DISPOSABLE HYGIENIC PRODUCTS
منتجات صحية - مستهلكات
- 15 PAPER PRODUCTS & SUPPLY
منتجات ورقية وكرتونية
- 16 CLEANING PRODUCTS & CLEANING MATERIALS
أدوات ومواد التنظيف
- 17 BAGS
أكياس التسوق والتفريز والنفايات
- 18 WRAPPING PRODUCTS
منتجات للتغليف
- 19 DISPOSABLE ALUMINUM TRAYS
صواني ألومنيوم

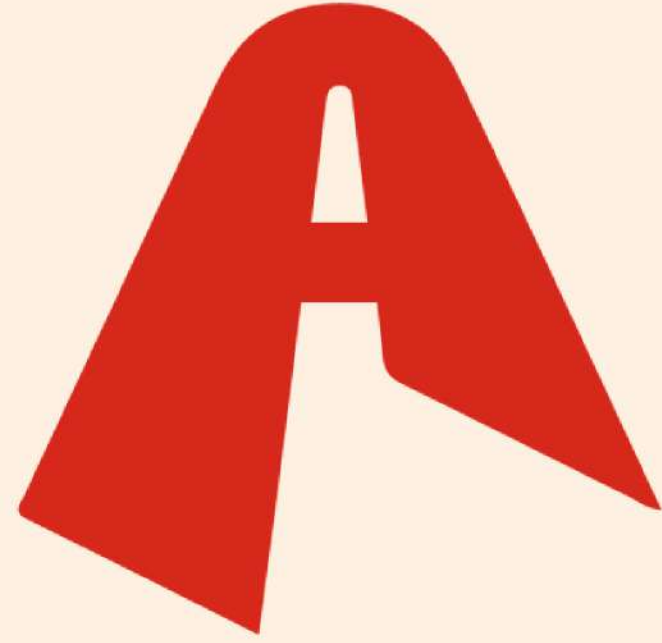

أدوات مائدة
بلاستيكية مستهلكة

PLASTIC CUTLERY & UTENCILS

خفيف

1.1 Light Duty Cutlery



1.1.1 Spoon



1.1.2 Fork



1.1.3 Knife



1.1.4 Spork

Light Duty Cutlery						
No.	Dec'n	Material	Dim. Cm	Int. Packing	Pcs/Ctn	Ctn Dim. Cm
1.1.1	Spoon	PS	15X3.0	50 Pcs	2000	39X32.5X26
1.1.2	Fork	PS	15X2.5	50 Pcs	2000	39X32.5X26
1.1.3	Knife	PS	16X1.5	50 Pcs	2000	34X31.5X23.5
1.1.4	Spork	PS	13.5X3.0	50 Pcs	2000	39X32.5X26
Colors		Transparent		White		Black

1.1.4 Spork



1.2.1 Spoon



1.2.2 Fork



1.2.3 Knife



1.2.4 Spork

Medium Duty Cutlery						
No.	Dec'n	Material	Dim. Cm	Int. Packing	Pcs/Ctn	Ctn Dim. Cm
1.2.1	Spoon	PS	16X3.8	50 Pcs	2000	39X32.5X26
1.2.2	Fork	PS	15X2.5	50 Pcs	2000	33.5X28.0X31
1.2.3	Knife	PS	16X2.0	50 Pcs	2000	34X31.5X23.5
1.2.4	Spork	PS	15X3.0	50 Pcs	2000	39X32.5X26
Colors		Transparent		White		Black



1.3.1 Spoon



1.3.2 Knife



1.3.3 Fork

Heavy Duty Cutlery (VIP)

No.	Dec'n	Material	Dim. Cm	Int. Packing	Pcs/Ctn	Ctn Dim. Cm
1.3.1	Spoon	PS	18X3.5	50 Pcs	1000	31X24.5X35
1.3.2	Fork	PS	18X2.5	50 Pcs	1000	31X24.5X35
1.3.3	Knife	PS	18X1.8	50 Pcs	2000	31X24.5X35
Colors		Transparent	White	Black	Gold	

سماكة عالية جداً

1.4 Super Heavy Duty Cutlery



1.4.1 Spoon



1.4.3 Knife



1.4.2 Fork



1.4.4 Spoon

Super Heavy Duty Cutlery

No.	Dec'n	Material	Dim. Cm	Int. Packing	Pcs/Ctn	Ctn Dim. Cm	Colors
1.4.1	Spoon	PS	15.5X3.5	50 Pcs	2000	33.5X28X31	■ ■ ■ □
1.4.2	Fork	PS	17.5X2.5	24 Pcs	4800	57X40.0X39	■
1.4.3	Knife	PS	19X2.0	24 Pcs	4800	57X40.0X28	■
1.4.4	Spoon	PS	19X4.0	50 Pcs	2000	33.5X28X31	■ ■ ■ □

سماكة عالية جداً
1.5 Plastic cutlery cutlery sets





1.6.1 Light Coffee Stirrer



1.6.2 Heavy Coffee Stirrer



1.6.3 Light Tea Spoon



1.6.4 Heavy Tea Spoon



1.6.5 Cocktail Stirrer

Stirrers						
No.	Dec'n	Material	Dim. Cm	Int. Packing	Pcs/Ctn	Ctn Dim. Cm
1.6.1	L. Coffee Stirrer	PS	11X.08	200 Pcs	12000	39X32.5X26
1.6.2	H. Coffee Stirrer	PS	13.3X1.5	200 Pcs	12000	56X45.5X32
1.6.3	L. Tea Spoon	PS	11X2.4	100 Pcs	10000	56X45.5X32
1.6.4	H. Tea Spoon	PS	12.5X2.7	200 Pcs	6000	57X46.5X32
1.6.5	Cocktail Stirrer	PS	17X4	200 Pcs	2000	39X32.5X26
Colors		Transparent	White	Black		

ملاعق بوظه

1.7 Ice-cream Spoons



1.7.1 Ice-cream Spoon



1.7.2 Ice-cream Spoon



1.7.3 Italian design Ice-cream Spoon

Ice-cream Spoon						
No.	Dec'n	Dim. Cm	Int. Packing	Pcs/Ctn	Approx. Weight	Ctn Dim. Cm
1.7.1	Ice-cream Spoon	9X2.2	520 Pcs	7800	15 Kgs	56.0X46.0X31
1.7.2	Ice-cream Spoon	8X2.0	625 Pcs	9350	15 Kgs	56.0X46.0X31
1.7.3	Italian design Ice-cream Spoon	9.5X2.0	500 Pcs	10000		56.0X46.0X31
1.7.4	Soft Ice-cream Spoon	12.5X2.7	200 Pcs	6000		53X42.0X29
1.7.5	Soft Ice-cream large Spoon	11X2.4	50 Pcs	2000		39X32.5X26
1.7.6	Pre-Packed Ice-cream Spoon	8X2.0	200 Pcs	4000		53.0X41.0X29
Colors		Transparent		White		Black



1.7.5 Soft Ice-cream large spoon



1.7.6 Pre-Packed Ice-cream Spoon



1.7.4 Soft Ice-cream Spoon

Ice-cream Spoon						
No.	Dec'n	Dim. Cm	Int. Packing	Pcs/Ctn	Approx. Weight	Ctn Dim. Cm
1.7.1	Ice-cream Spoon	9X2.2	520 Pcs	7800	15 Kgs	56.0X46.0X31
1.7.2	Ice-cream Spoon	8X2.0	625 Pcs	9350	15 Kgs	56.0X46.0X31
1.7.3	Italian design Ice-cream Spoon	9.5X2.0	500 Pcs	10000		56.0X46.0X31
1.7.4	Soft Ice-cream Spoon	12.5X2.7	200 Pcs	6000		53X42.0X29
1.7.5	Soft Ice-cream large Spoon	11X2.4	50 Pcs	2000		39X32.5X26
1.7.6	Pre-Packed Ice-cream Spoon	8X2.0	200 Pcs	4000		53.0X41.0X29
Colors		Transparent		White		Black



1.8.1 Cake Knife



1.8.2 Pizza Saver



1.8.3 Joint Knife



1.8.4 French Fries Fork

Miscellaneous Plastic Products

Item No.:	Material	Dim. cm	Int. Packing	Pcs/Ctn	Ctn Dim. cm
1.8.1	PS	22X5X3.0	100 Pcs	500	33X27.5X28
1.8.2	PP	Ø4.5X3.5	100 Pcs	2500	53X41.0X29
1.8.3	PS	19X10	10 Pcs	400	39X32.5X26
1.8.4	PS	8.5X1.5	1000 Pcs	10000	53X41.0X29



1.8.5 Ice Bucket cooler



1.8.6 Ice Clamp



1.8.7 Serving Spoon (flat)

Miscellaneous Plastic Products						
Item No.:	Material		Dim. cm	Int. Packing	Pcs/Ctn	Ctn Dim. cm
1.8.5	PS		Ø11.5X12	12 Pcs	48	53X25.5X12.5
1.8.6	PP		15X5X2.5	500 Pcs	500	53X41.5X29
1.8.7	PS		26X9.0	12 Pcs	240	53X41.5X29
1.8.8	PP		20X5.0X1.5	12 Pcs	240	39X32.5X26
1.8.9	PS		11X3.0X1.0	100 Pcs	2000	53X41.5X29



1.8.8 Rice Serving Spoon



1.8.9 Small Clamp

Miscellaneous Plastic Products						
Item No.:	Material		Dim. cm	Int. Packing	Pcs/Ctn	Ctn Dim. cm
1.8.5	PS		Ø11.5X12	12 Pcs	48	53X25.5X12.5
1.8.6	PP		15X5X2.5	500 Pcs	500	53X41.5X29
1.8.7	PS		26X9.0	12 Pcs	240	53X41.5X29
1.8.8	PP		20X5.0X1.5	12 Pcs	240	39X32.5X26
1.8.9	PS		11X3.0X1.0	100 Pcs	2000	53X41.5X29

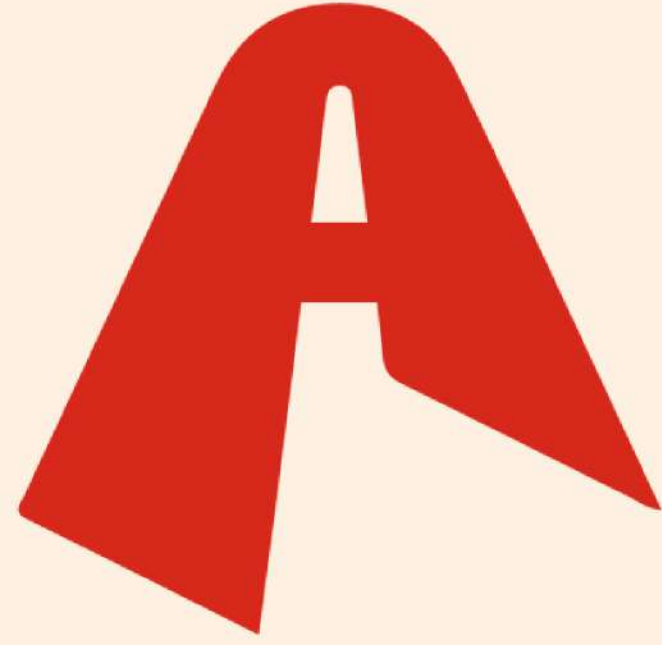

علب حلويات شفافه
متعددة الإستعمال

MULTY-PURPOSE CRYSTAL BOXES

علب شفاف دائري
2.1 Round Shape Boxes



2.1.1 Ø 16X6cm Cap.: ½ kg



2.1.2 Ø 17.5X5cm Cap.: ½ kg



2.1.3 Ø 22.3X4cm Cap.: 1 kg

ROUND SHAPE BOXES						
Item No.:	Material	Capacity	Dim. cm	Int. Packing	Pcs/Sack	Sack Dim. cm
2.1.1	PS	½ Kg	Ø 16X6	20 Pcs	20	60X32X16.0
2.1.2	PS	½ Kg	Ø 17.5X5	20 Pcs	20	50X35X17.5
2.1.3	PS	1 Kg	Ø 22.3X4	30 Pcs	30	60X44.6X22.3
2.1.4						
2.1.5	PS	1½ Kg	Ø 22.3X6	20 Pcs	20	60X44.6X22.3
2.1.6	PS	2 Kg	Ø 31X4	10 Pcs	10	40.0X31.0X31
Colors	Transparent					



ROUND SHAPE BOXES						
Item No.:	Material	Capacity	Dim. cm	Int. Packing	Pcs/Sack	Sack Dim. cm
2.1.1	PS	½ Kg	Ø 16X6	20 Pcs	20	60X32X16.0
2.1.2	PS	½ Kg	Ø 17.5X5	20 Pcs	20	50X35X17.5
2.1.3	PS	1 Kg	Ø 22.3X4	30 Pcs	30	60X44.6X22.3
2.1.4						
2.1.5	PS	1½ Kg	Ø 22.3X6	20 Pcs	20	60X44.6X22.3
2.1.6	PS	2 Kg	Ø 31X4	10 Pcs	10	40.0X31.0X31
Colors	Transparent					

علب مربعة الشكل
2.2 Square Shape Boxes



2.2.1 23X23X3.5cm Cap.:
1 kg



2.2.2 23X23X4.5cm Cap.:
1½ kg

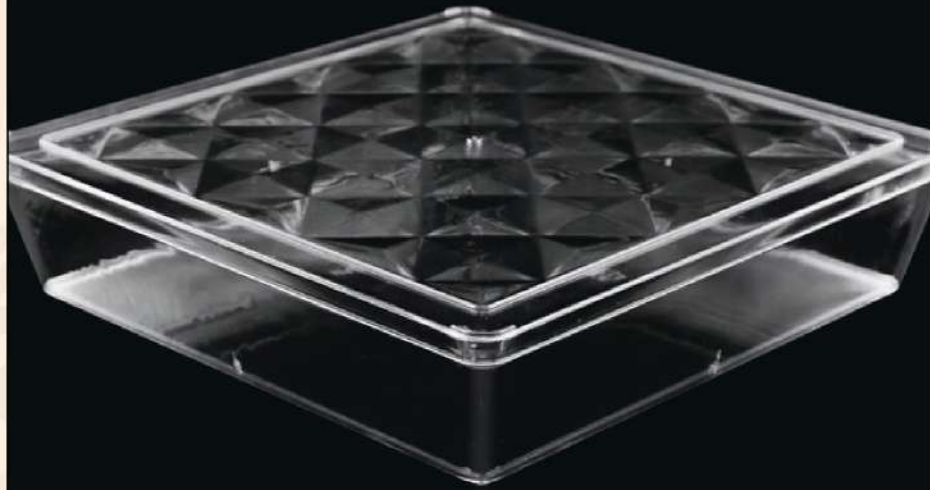

2.2.3 23.5X23.5X5.5cm Cap.:
1½ kg

SQUARE SHAPE BOXES

Item No.:	Material	Capacity	Dim. cm	Int. Packing	Pcs/Sack	Sack Dim. cm
2 .2 .1	PS	1 Kg	23X23X3.5	30 Pcs	30	53X46X23
2 .2 .2	PS	1½ Kg	23X23X4.5	20 Pcs	20	45X46X23
2 .2 .3	PS	1½Kg	23.5X23.5X5.5	20 Pcs	20	55X47X23.5
Colors	Transparent					

علب مستطيلة الشكل

2.3 Rectangular Shape Boxes



2.3.1 16x12x3cm Cap.:
¼ kg



2.3.2 20x16x3.8cm Cap.:
½ kg



2.3.3 24x19x3.5cm Cap.:
1 kg

RECTANGULAR SHAPE BOXES

Item No.:	Material	Capacity	Dim. cm	Int. Packing	Pcs/Sack	Sack Dim. cm
2.3.1	PS	¼ Kg	16X12X3	40 Pcs	40	22.5 X32.5X30
2.3.2	PS	½ Kg	20X16X3.8	20 Pcs	20	55 X32.0X20
2.3.3	PS	1 Kg	24X19X3.5	20 Pcs	20	55X38.0X24
2.3.4	PS	1½ Kg	28X23X3.5	10 Pcs	10	55X28.0X23
2.3.5	PS	2 Kg	32X27X3.8	10 Pcs	10	55X32.0X27
2.3.6	PS	2 Kg	33.5X24X4	24 Pcs	24	56X46.0X32
Colors	Transparent		Brown		Gold	

علب مستطيلة الشكل

2.3 Rectangular Shape Boxes



2.3.4 28x23x3.5cm Cap.:
1½ kg



2.3.5 32x27x3.8cm Cap.:
2 kg



2.3.6 33.5x24x4cm Cap.:
2 kg

RECTANGULAR SHAPE BOXES

Item No.:	Material	Capacity	Dim. cm	Int. Packing	Pcs/Sack	Sack Dim. cm
2.3.1	PS	¼ Kg	16X12X3	40 Pcs	40	22.5 X32.5X30
2.3.2	PS	½ Kg	20X16X3.8	20 Pcs	20	55 X32.0X20
2.3.3	PS	1 Kg	24X19X3.5	20 Pcs	20	55X38.0X24
2.3.4	PS	1½ Kg	28X23X3.5	10 Pcs	10	55X28.0X23
2.3.5	PS	2 Kg	32X27X3.8	10 Pcs	10	55X32.0X27
2.3.6	PS	2 Kg	33.5X24X4	24 Pcs	24	56X46.0X32
Colors	Transparent		Brown		Gold	

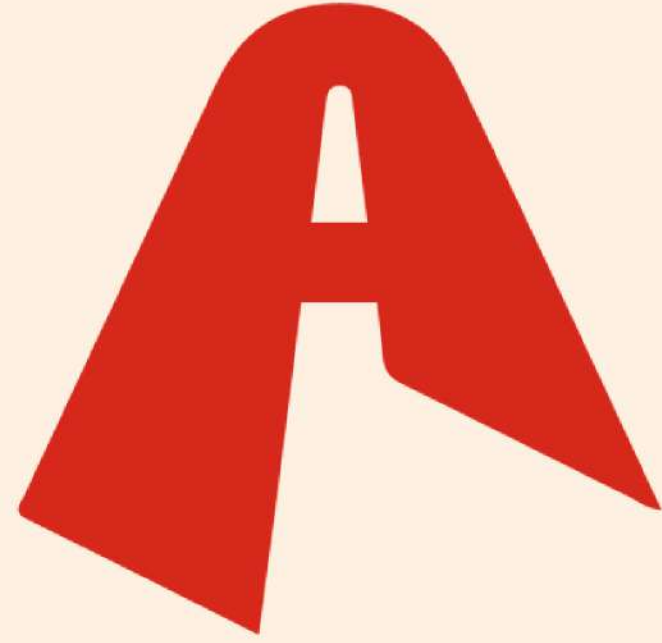

صحون حلويات ومقيلات
شفاقة متعددة الاستخدام

MULTY-PURPOSE CRYSTAL PLATES

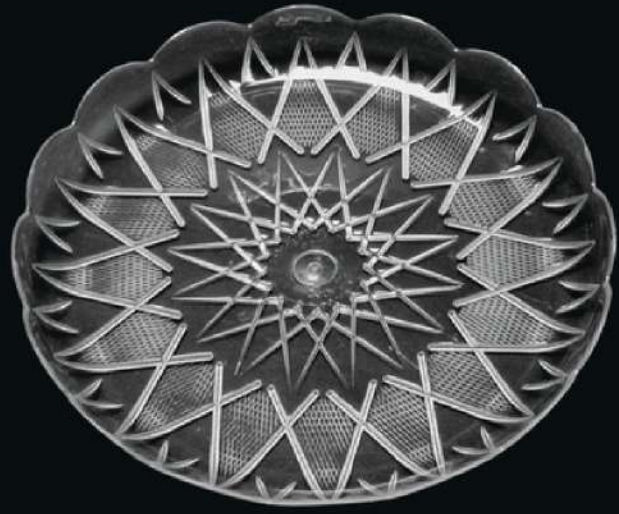

3.1.1 Ø 20X2cm Cap.: ½ kg

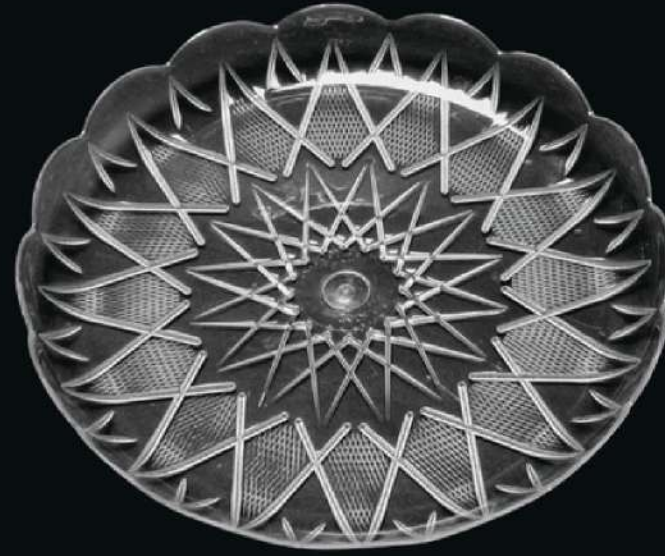

3.1.2 Ø 24X2cm Cap.: ¾ kg

Round Plates						
Item No.:	Material	Capacity	Dim. cm	Int. Packing	Pcs/Ctn	Ctn Dim. cm
3 . 1 . 1	PS	½ Kg	Ø 20X2	100 Pcs	100	42X21X25
3 . 1 . 2	PS	¾ Kg	Ø 24X2	100 Pcs	100	49 X25X23
3 . 1 . 3	PS	1 Kg	Ø 27X2.3	80 Pcs	80	28X28X27.5
3 . 1 . 4	PS	1½ Kg	Ø 30X2.3	80 Pcs	80	30.5X30.5X41.5
Color	Transparent					

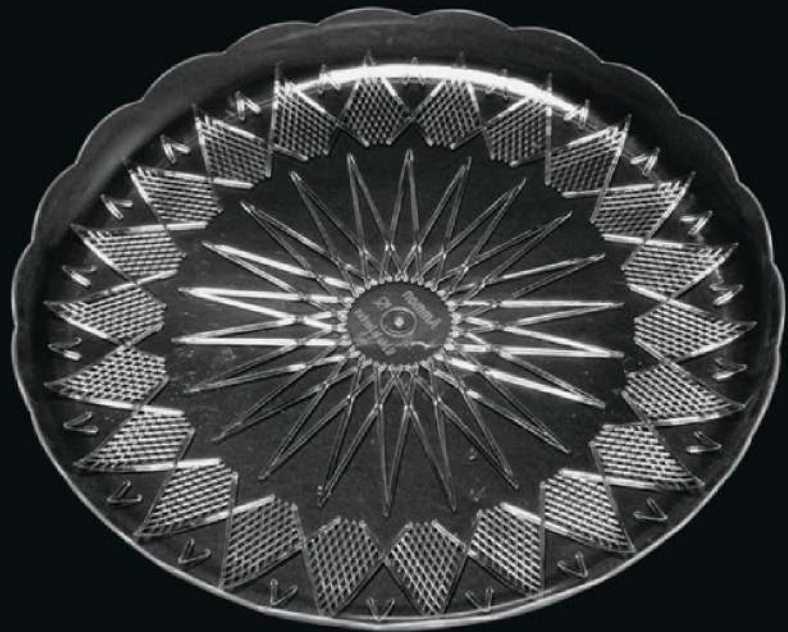

3.1.3 Ø 27X2.3cm Cap.: 1 kg

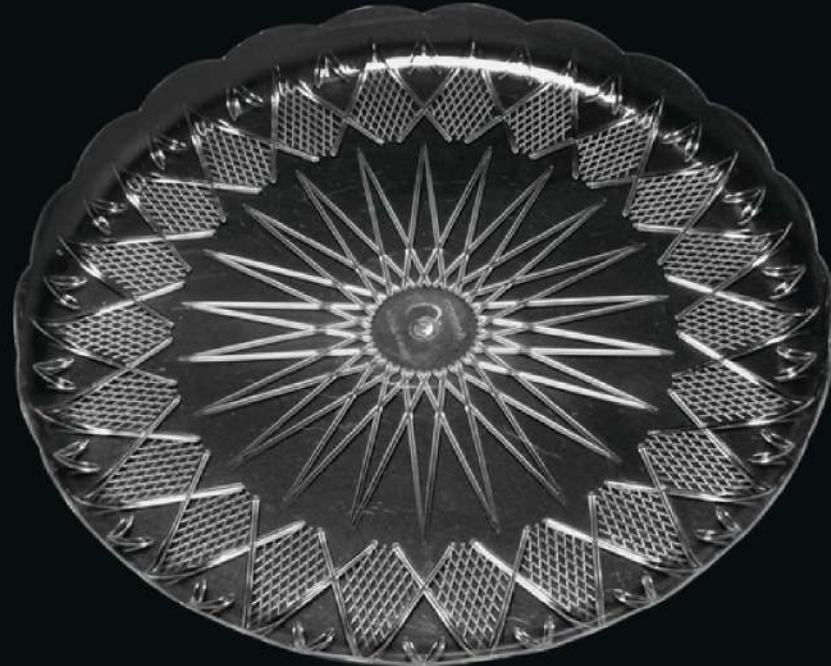

3.3.4 Ø 30X2.3cm Cap.:
1½ kg

Round Plates						
Item No.:	Material	Capacity	Dim. cm	Int. Packing	Pcs/Ctn	Ctn Dim. cm
3 .1 .1	PS	½ Kg	Ø 20X2	100 Pcs	100	42X21X25
3 .1 .2	PS	¾ Kg	Ø 24X2	100 Pcs	100	49 X25X23
3 .1 .3	PS	1 Kg	Ø 27X2.3	80 Pcs	80	28X28X27.5
3 .1 .4	PS	1½ Kg	Ø 30X2.3	80 Pcs	80	30.5X30.5X41.5
Color		Transparent				

جاٹ کریسٹال دائری
3.1 Round Plates



3.1.5 Ø 33X2.3cm Cap:2 kg



3.1.6 Ø 36X2.5 cm Cap:2½ kg



3.1.8 Ø 45X2.5 cm Cap:4 kg

Round Plates						
Item No.:	Material	Capacity	Dim. cm	Int. Packing	Pcs/Ctn	Ctn Dim. cm
3.1.5	PS	2 Kg	Ø 33X2.3	80 Pcs	80	33.5X33.5X24
3.1.6	PS	2 ½ Kg	Ø 36X2.5	50 Pcs	50	36.5X36.5X23.5
3.1.8	PS	4 Kg	Ø 45X2.5	24 Pcs	24	42.5x45.5x10
Color	Transparent					

صحنون شفاف مربع
3.2 Square Plates



3.2.1 17x17x2cm Cap: ½ kg



3.2.2 23X23X2.5cm Cap: 1 kg

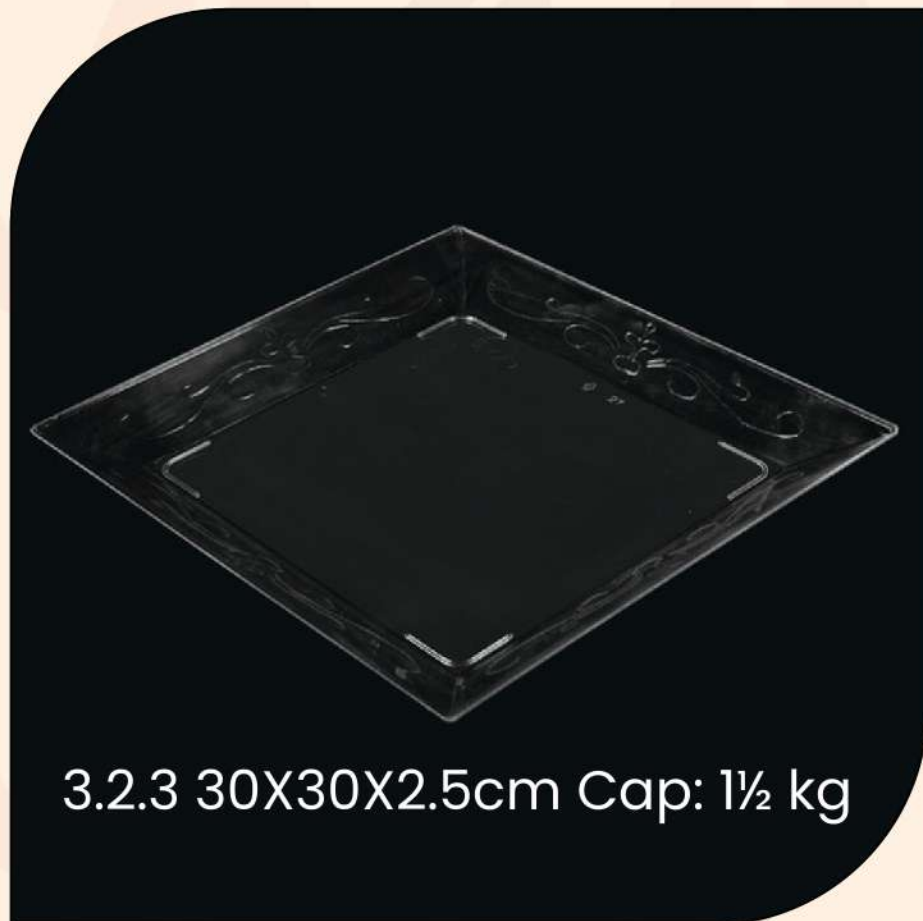

3.2.3 30X30X2.5cm Cap: 1½ kg

Square Platas						
Item No.:	Material	Capacity	Dim. cm	Int. Packing	Pcs/Ctn	Ctn. Dim. cm
3 .2 .1	PS	½ Kg	17X17X2.5	100 Pcs	100	17.5×17.5x18.0
3 .2 .2	PS	1 Kg	23X23X3.0	100 Pcs	100	23.5×23.5x18.0
3 .2 .3	PS	1½ Kg	30X30X3.0	80 Pcs	80	30.5×30.5x18.0
Color	Transparent					

صحنون شفاف مستطيل
3.3 Rectangular Plates

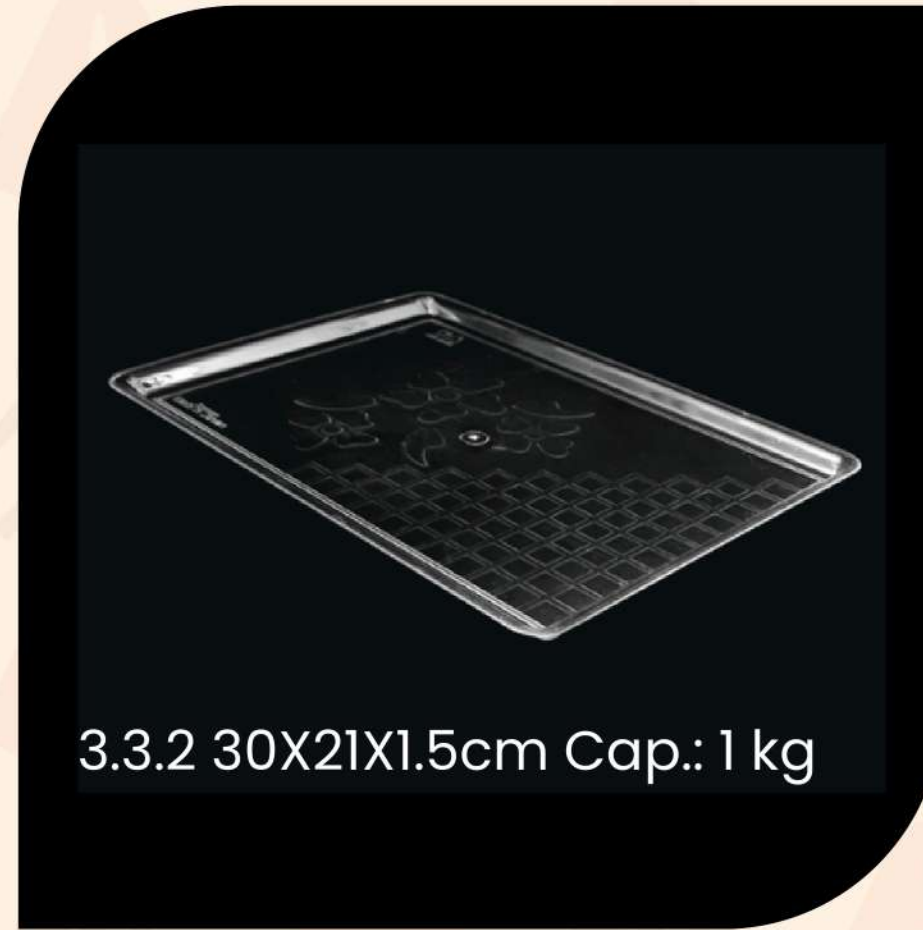

Rectangular Plates						
Item No.:	Material	Capacity	Dim. cm	Int. Packing	Pcs/Ctn	Ctn. Dim. cm
3 .3 .1	PS	½ Kg	21X16X1.5	100 Pcs	100	32X23X21
3 .3 .2	PS	1 Kg	30X21X1.5	50 Pcs	50	32X23X21
3 .3 .3	PS	1½ Kg	35X25X1.5	50 Pcs	50	36X26X32
Color	Transparent					



3.4.1 28.5x19.0x3.0 cm Cap.: ½ kg



3.4.2 28.5X22.5X3.0cm Cap.: ¾ kg

Rectangular Plates						
Item No.:	Material	Capacity	Dim. cm	Int. Packing	Pcs/Ctn	Sack Dim. cm
3 .4 .1	PS	½ Kg	28.5X19.0X3.0	100 Pcs	100	29.5X20X27
3 .4 .2	PS	¾ Kg	28.5X22.5X3.0	50 Pcs	50	31X24X35
3 .4 .3	PS	1 Kg	34X27X3.0	50 Pcs	50	36.0X28X31
3 .4 .4	PS	1½ Kg	42X27X3.0	50 Pcs	50	43X29X32
Color	Transparent		White		Gold	



3.4.3 34.0X27.0X3.0cm Cap.: 1 kg



3.4.4 42.0X27.0X3.0 cm Cap.: 1½ kg

Rectangular Plates						
Item No.:	Material	Capacity	Dim. cm	Int. Packing	Pcs/Ctn	Sack Dim. cm
3 .4 .1	PS	½ Kg	28.5X19.0X3.0	100 Pcs	100	29.5X20X27
3 .4 .2	PS	¾ Kg	28.5X22.5X3.0	50 Pcs	50	31X24X35
3 .4 .3	PS	1 Kg	34X27X3.0	50 Pcs	50	36.0X28X31
3 .4 .4	PS	1½ Kg	42X27X3.0	50 Pcs	50	43X29X32
Color	Transparent		White		Gold	

صحنون شفاف مستطيل
3.5 Rectangular Plates



3.5.1 19.5X15X2.25 cm Cap.: ¼ kg



3.5.2 25X21X2.25 cm Cap.: ½ kg



3.5.3 32X25X2.25 cm Cap.: 1 kg

Rectangular Plates						
Item No.:	Material	Capacity	Dim. cm	Int. Packing	Pcs/Ctn	Ctn. Dim. cm
3 .5 .1	PS	¼ Kg	19X15X2.25	100 Pcs	100	19.5X31X20
3 .5 .2	PS	½ Kg	25X21X2.25	50 Pcs	50	26.0X22.0X22
3 .5 .3	PS	1 Kg	32X25X2.25	50 Pcs	50	33.0X27.0X27.0
Color	Transparent					

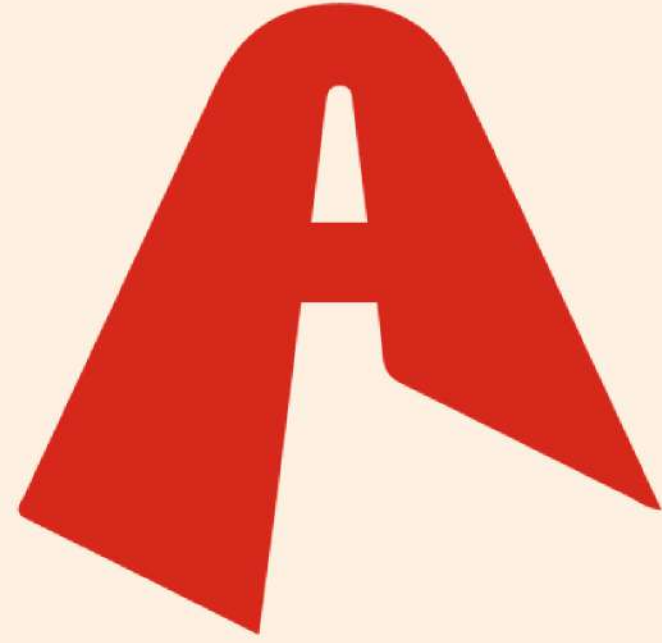

طحون حفلات مقوية

PLASTIC PARTY PLATES



Heavy Duty Party Plates								
No.	Dec'n	Material	Ø	Int. Packing	Pcs/Ctn	Ctn Dim. cm		
4.1.1	Dessert Plate	PS	19 Cm	200	200	39X20.0X16.5		
4.1.2	Appatizar Plate	PS	23 Cm	200	200	47.5X45X19.5		
4.1.3	Main Course Plate	PS	27 Cm	130	120	28.0X28.0X29		
Colors		Transparent	White	Black	Pink	Blue	Gold	Silver

صحنون حفلات مقوي
4.1 Heavy Duty Party Plates



4.2.1 (ø 18)



4.2.2 (ø 22)

Party Plates - Round					
No.	Material	Dim. cm	Int. Packing	Pcs/Ctn	Ctn Dim. cm
4.2.1	PET	ø 18	50	1000	38.5X34X28
4.2.2	PET	ø 22	50	600	45X45X27
Color		Transparent			

صحون حفلات مستطيله
4.3 Party Plates - Rectangular



4.3.1 (17X12X2.5 cm)



4.3.2 (21X15.5X2.5 cm)

Party Plates - Rectangular					
No.	Material	Dim. cm	Int. Packing	Pcs/Ctn	Ctn Dim. cm
4.3.1	PET	17X12X2.5	50	1000	25X18X30
4.3.2	PET	21X15.5X2.5	50	1000	30X20X30
4.3.3	PET	24X17.5X2.5	50	500	24.5X17.5X30
4.3.4	PET	27.5X19.5X2.5	50	500	30X20X30
Color		Transparent			

صحون حفلات مستطيله
4.3 Party Plates - Rectangular



4.3.3 (24X17.5X2.5 cm)



4.3.4 (27.5X19.5X2.5 cm)

Party Plates - Rectangular					
No.	Material	Dim. cm	Int. Packing	Pcs/Ctn	Ctn Dim. cm
4.3.1	PET	17X12X2.5	50	1000	25X18X30
4.3.2	PET	21X15.5X2.5	50	1000	30X20X30
4.3.3	PET	24X17.5X2.5	50	500	24.5X17.5X30
4.3.4	PET	27.5X19.5X2.5	50	500	30X20X30
Color		Transparent			

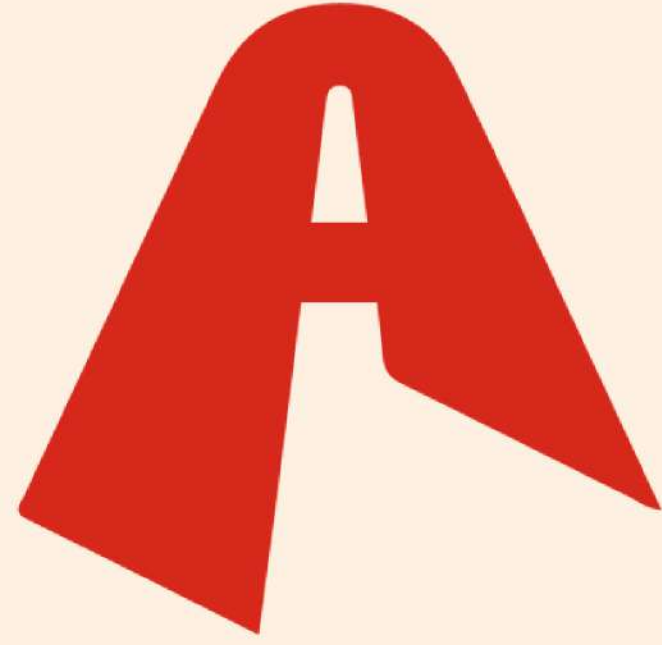

قواعد كيك

CAKE BOARDS

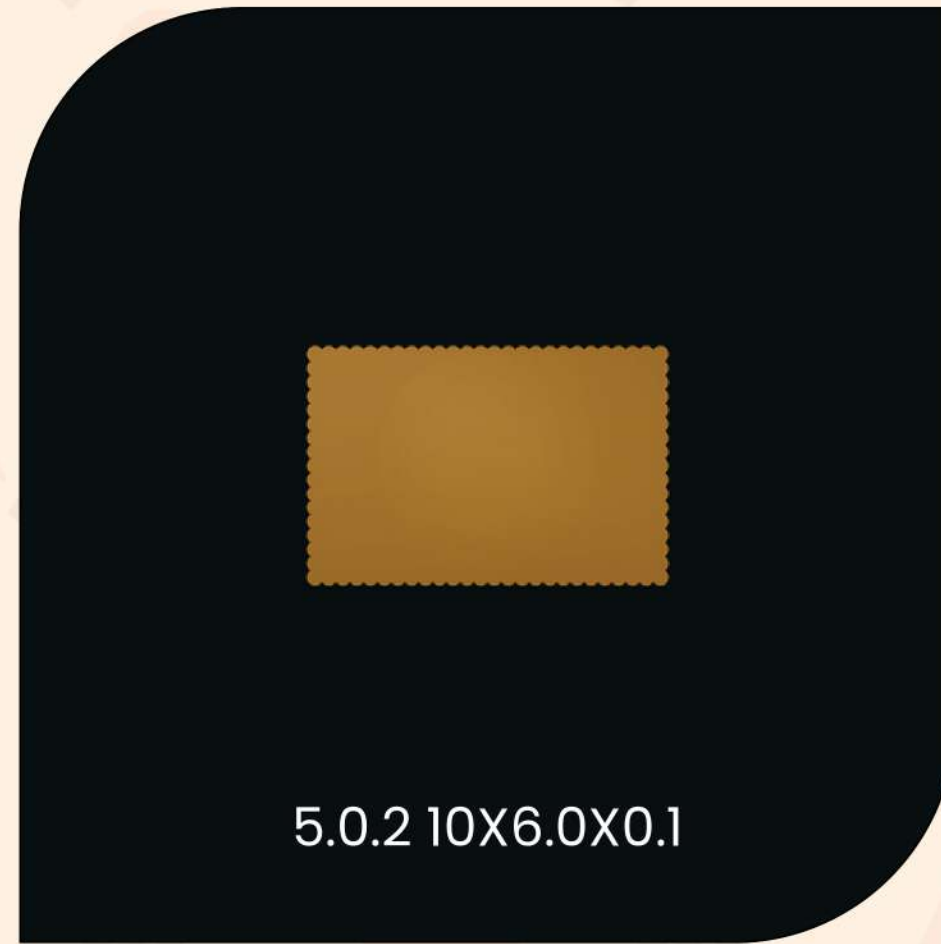
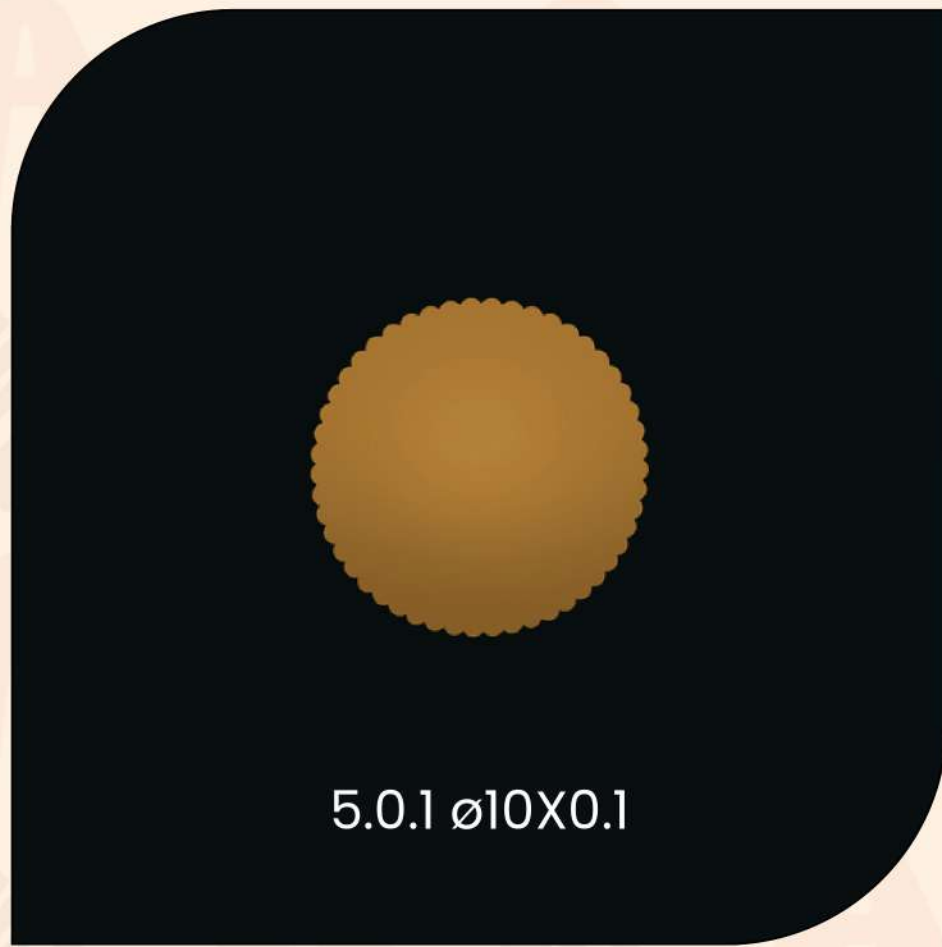

Cake Bases					
Item No.:	Material	Dim. Cm	Int. Packing	Pcs/ Ctn.	Ctn. Dim.
5.0.1	PS	ø10X0.1	125 Pcs	1000	20.5X20.5X25.5
5.0.2	PS	10X6.0X0.1	125 Pcs	1000	25.5X20.5X12.5
5.0.3	PS	ø25X0.5	100 Pcs	100	51X26.5X20.5
5.0.4	PS	ø31X0.5	100 Pcs	100	31.5X31.5X22
5.0.5	PS	ø36.5X0.5	80 Pcs	100	36.5X36.5X23.5
Color	Beige	White	Gold	Silver	Black



Cake Bases					
Item No.:	Material	Dim. Cm	Int. Packing	Pcs/ Ctn.	Ctn. Dim.
5.0.1	PS	ø10X0.1	125 Pcs	1000	20.5X20.5X25.5
5.0.2	PS	10X6.0X0.1	125 Pcs	1000	25.5X20.5X12.5
5.0.3	PS	ø25X0.5	100 Pcs	100	51X26.5X20.5
5.0.4	PS	ø31X0.5	100 Pcs	100	31.5X31.5X22
5.0.5	PS	ø36.5X0.5	80 Pcs	100	36.5X36.5X23.5
Color	Beige	White	Gold	Silver	Black

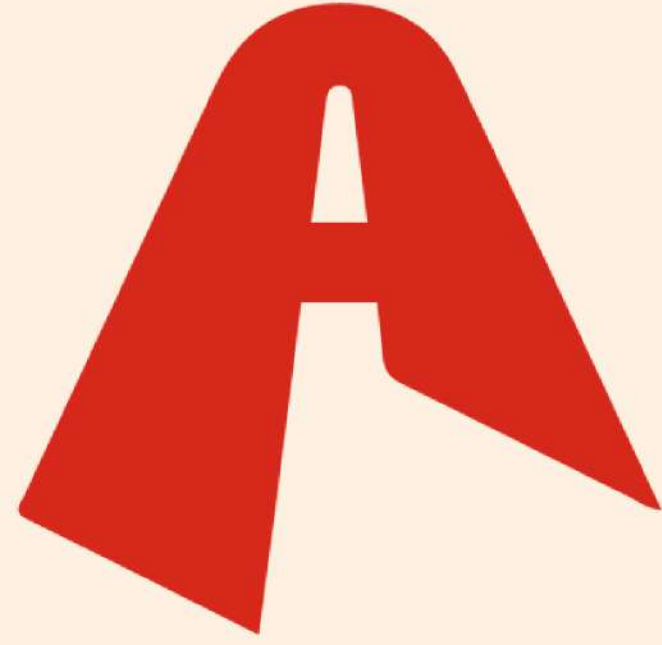

طواني تقديم الطعام

SERVING TRAYS



Serving Trays					
Item No.:	Material	Dim. Cm	Int. Packing	Pcs Sack	Sack Dim.
6.0.1	PS/PP	34.5X26.5X2.0	12 Pcs	12	35X27X12
6.0.2	PS/PP	41.5X30.5X2.0	12 Pcs	12	42X31X12
6.0.3	PS/PP	45.5X35.5X2.0	12 Pcs	12	46X36X12
Color	Beige	Orange	Dark Red	Brown	Black

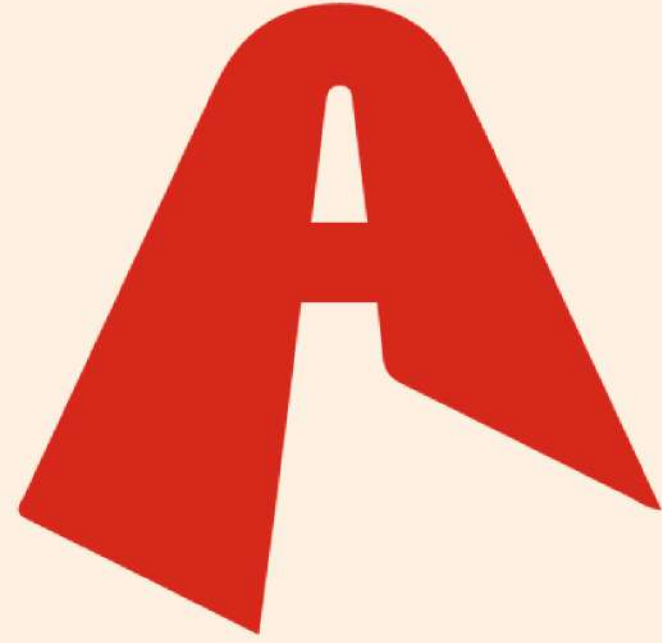

علب وكاسات للبوظة
والحلويات

ICE - CREAM BOWLS & DESSERT CUPS

علب وكاسات للبوطة والحلويات

7.1 Ice - Cream Bowls & Dessert Cups



7.1.1 (5X5X5 cm) Cap.: 60 cc

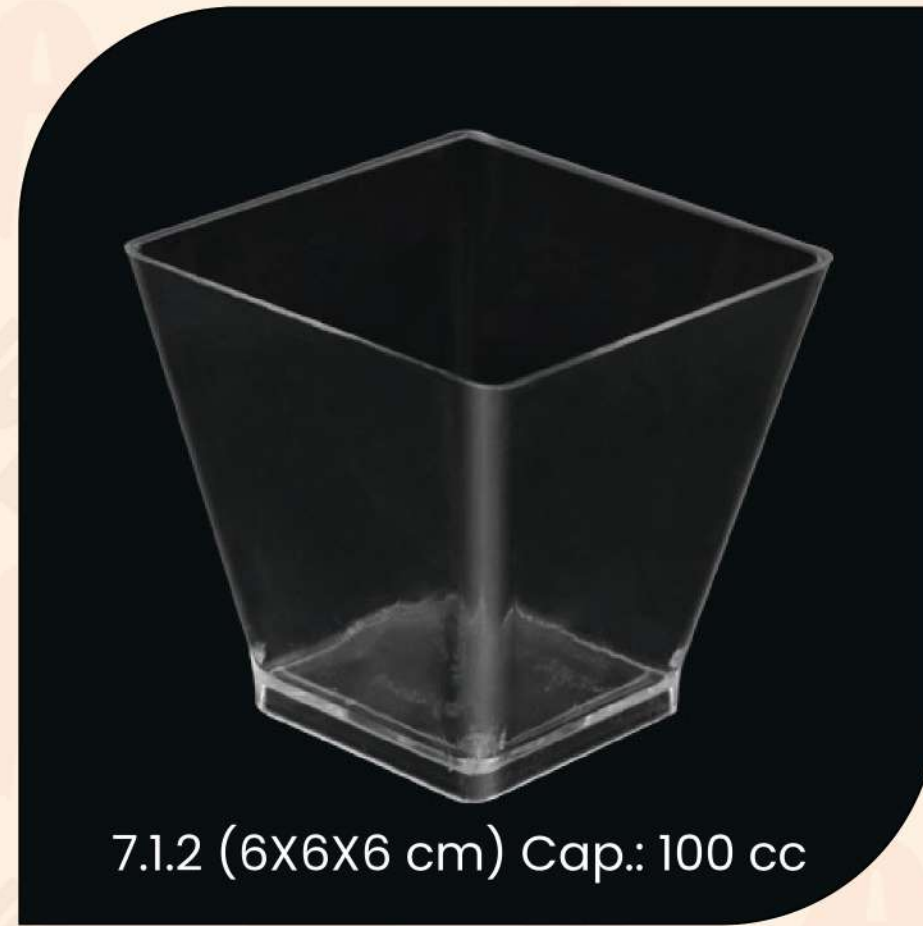

7.1.2 (6X6X6 cm) Cap.: 100 cc

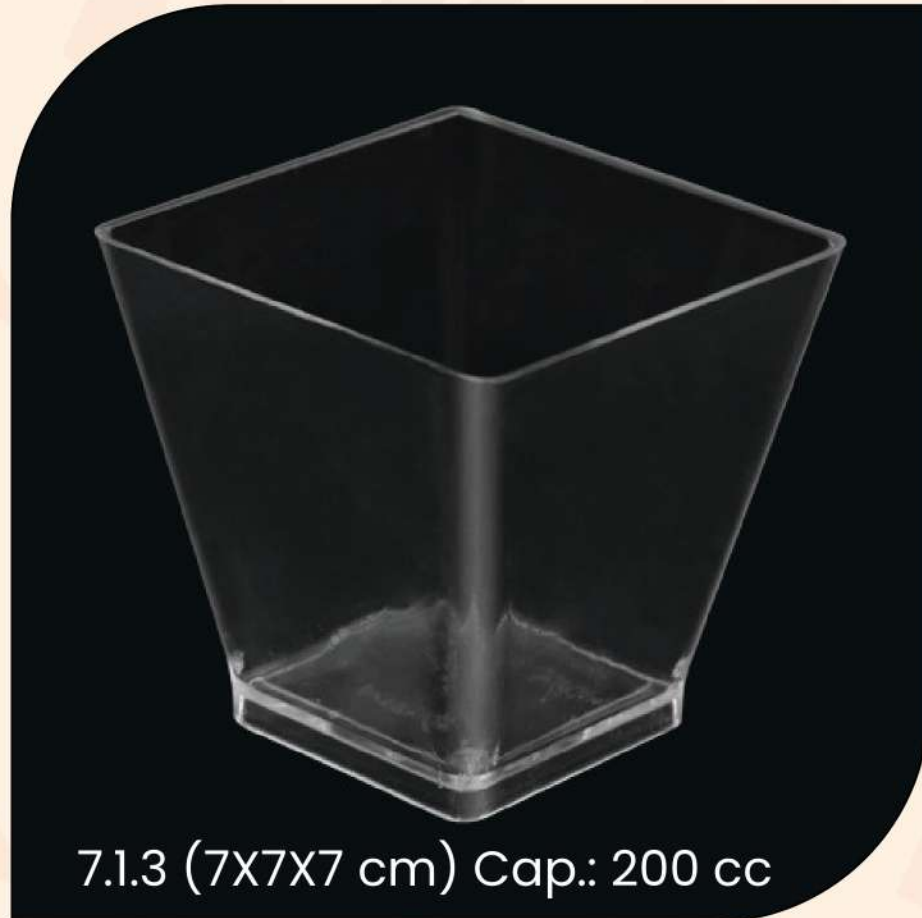

7.1.3 (7X7X7 cm) Cap.: 200 cc

Ice - Cream Bowls & Dessert Cups						
Item No.:	Material	Capacity	Dim. cm	Int. Packing	Pcs/Ctn	Ctn Dim. cm
7.1.1	PS	60 cc	5X5X5	25 Pcs	500	32X32X20
7.1.2	PS	100 cc	6X6X6	25 Pcs	500	37X37X24
7.1.3	PS	200 cc	7X7X7	25 Pcs	500	49.5X49.5X28
7.1.4	PS	160 cc	Ø 6X9.5	50 Pcs	500	49X31X56.5
7.1.5	PS	200 cc	8X8X8	50 Pcs	450	28.5X28.5X26
7.1.6	PS	200 cc	8.5X8.5X5.5	50 Pcs	1000	47X42X32
LID 7.1.6	PS			50 Pcs	1000	48X41X17
Color	Transparent					

علب وكاسات للبوطة والحلويات

7.1 Ice - Cream Bowls & Dessert Cups



7.1.4 (Ø 6X9.5) Cap.: 160 cc



7.1.5 (8X8X8 cm) Cap.: 200 cc

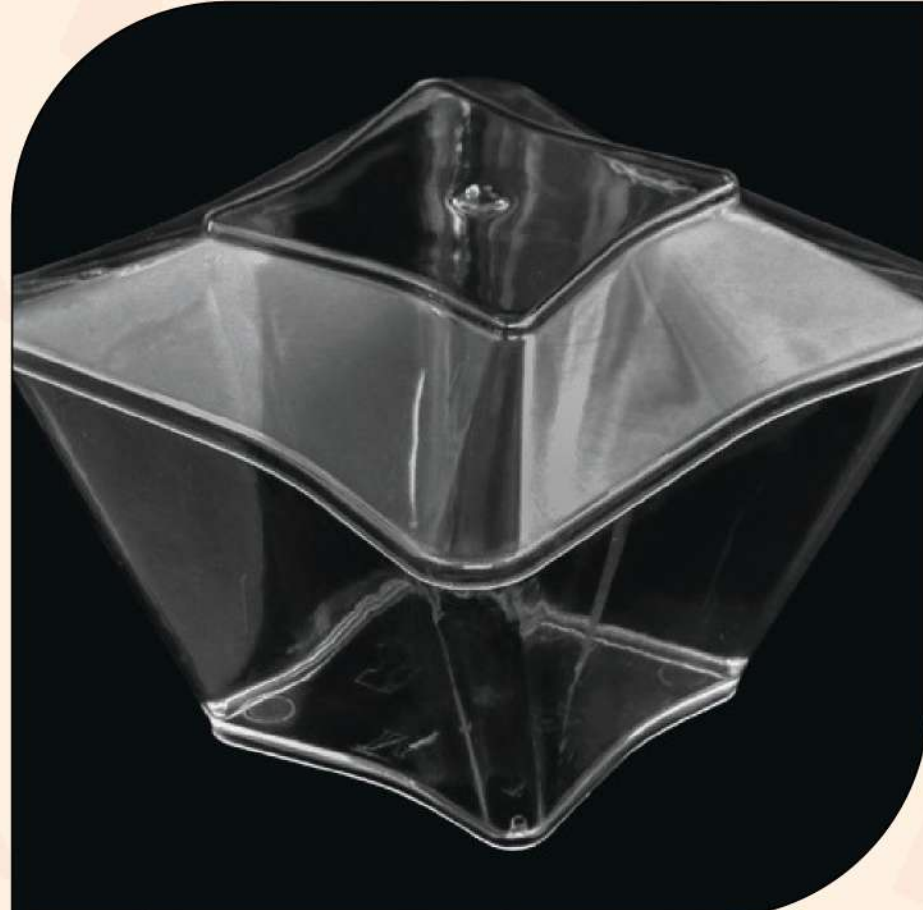

7.1.6 (8.5X8.5X5.5 cm) Cap.: 200 cc

Ice - Cream Bowls & Dessert Cups						
Item No.:	Material	Capacity	Dim. cm	Int. Packing	Pcs/Ctn	Ctn Dim. cm
7.1.1	PS	60 cc	5X5X5	25 Pcs	500	32X32X20
7.1.2	PS	100 cc	6X6X6	25 Pcs	500	37X37X24
7.1.3	PS	200 cc	7X7X7	25 Pcs	500	49.5X49.5X28
7.1.4	PS	160 cc	Ø 6X9.5	50 Pcs	500	49X31X56.5
7.1.5	PS	200 cc	8X8X8	50 Pcs	450	28.5X28.5X26
7.1.6	PS	200 cc	8.5X8.5X5.5	50 Pcs	1000	47X42X32
LID 7.1.6	PS			50 Pcs	1000	48X41X17
Color	Transparent					

علب وكاسات للبوطة والحلويات

7.1 Ice - Cream Bowls & Dessert Cups

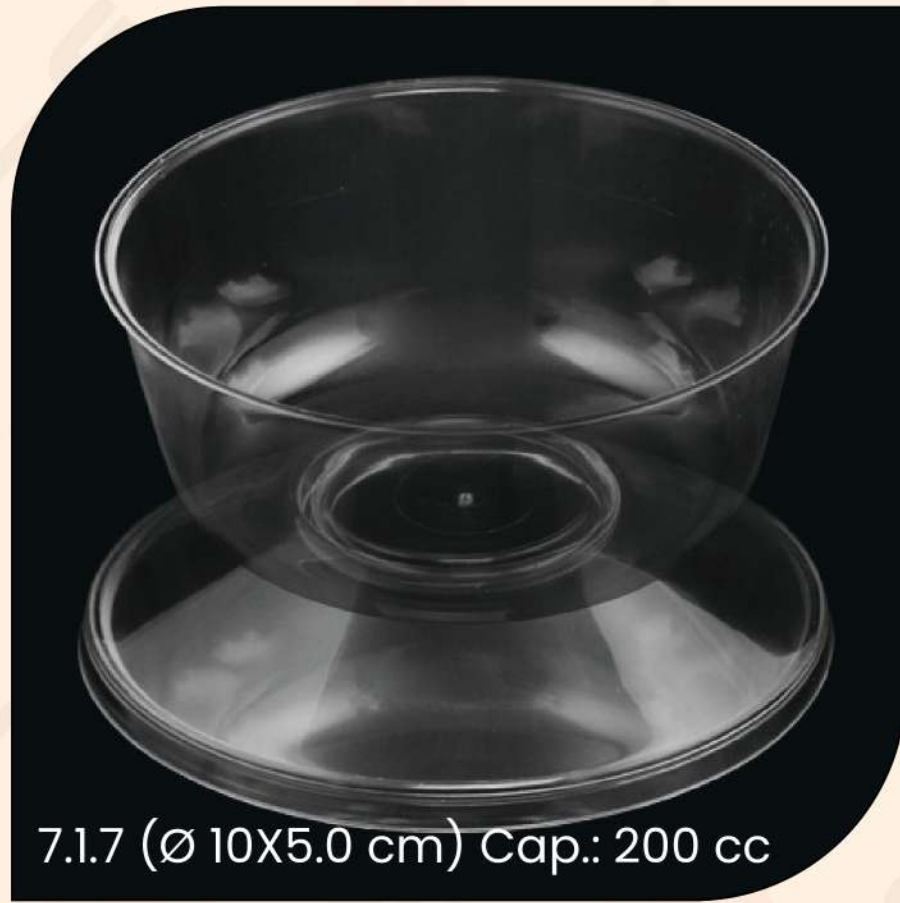

7.1.7 (Ø 10X5.0 cm) Cap.: 200 cc



7.1.8 (Ø 7.5X4.3 cm) Cap.: 100 cc



7.1.9 (Ø 8.5X5.5) Cap.: 200 cc



7.2.0 (Ø 10X4.5 cm) Cap.: 200 cc

Ice - Cream Bowls & Dessert Cups

Item No.:	Material	Capacity	Dim. cm	Int. Packing	Pcs/Ctn	Ctn Dim. cm
7.1.7	PS	200 cc	Ø 10X5.0	50 Pcs	500	52X42X32
7.1.8	PET	100 cc	Ø 7.5X4.3	50 Pcs	2500	60X52X38
7.1.9	PET	200 cc	Ø 8.5X5.5	100 Pcs	1000	43.5X30.5X34
7.2.0	PET	200 cc	Ø 10X4.5	100 Pcs	1000	55X50X21
7.2.1	PET	250 cc	Ø 10X6.5	100 Pcs	1000	55X50X21
LID 7.1.8	PET			100 Pcs	2500	49.5X39X33
LID 7.1.9	PET			100 Pcs	1000	38.5X34X28
LID 7.2.0 & 7.2.1	PET			100 Pcs	1000	48X41X17
Color	Transparent					

علب وكاسات للبوطة والحلويات

7.1 Ice - Cream Bowls & Dessert Cups



7.2.1 (Ø 10X6.5 cm) Cap.: 250 cc



LID 7.1.8

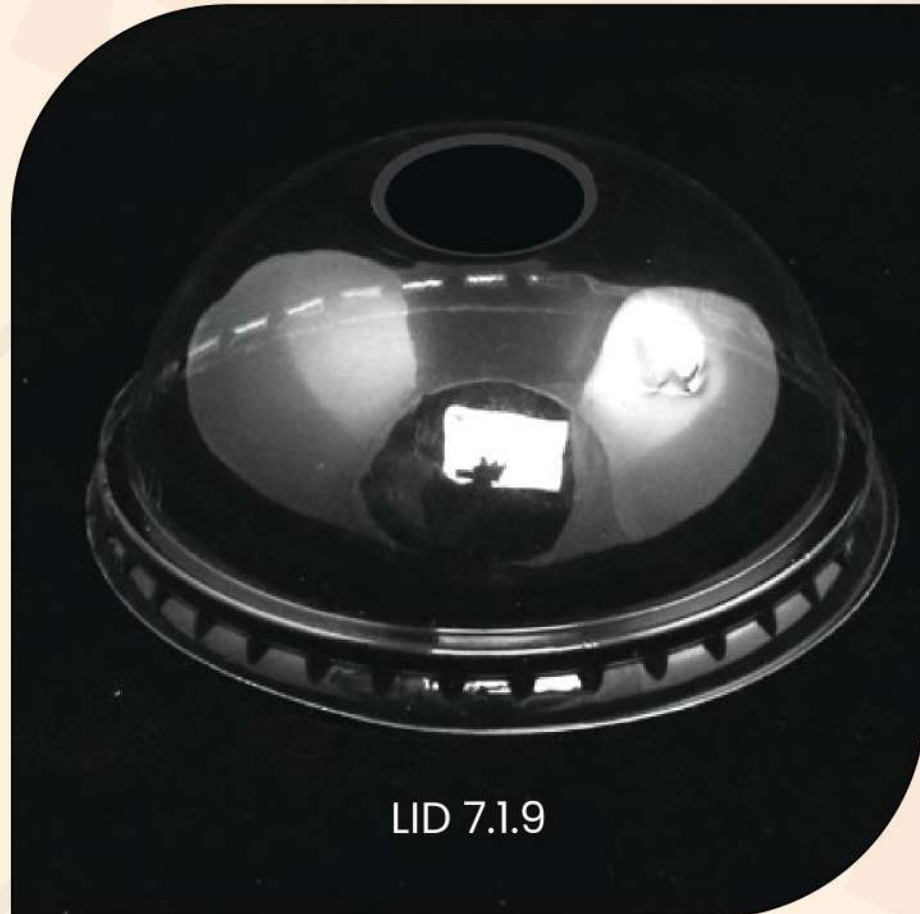

LID 7.1.9

Ice - Cream Bowls & Dessert Cups						
Item No.:	Material	Capacity	Dim. cm	Int. Packing	Pcs/Ctn	Ctn Dim. cm
7.1.7	PS	200 cc	Ø 10X5.0	50 Pcs	500	52X42X32
7.1.8	PET	100 cc	Ø 7.5X4.3	50 Pcs	2500	60X52X38
7.1.9	PET	200 cc	Ø 8.5X5.5	100 Pcs	1000	43.5X30.5X34
7.2.0	PET	200 cc	Ø 10X4.5	100 Pcs	1000	55X50X21
7.2.1	PET	250 cc	Ø 10X6.5	100 Pcs	1000	55X50X21
LID 7.1.8	PET			100 Pcs	2500	49.5X39X33
LID 7.1.9	PET			100 Pcs	1000	38.5X34X28
LID 7.2.0 & 7.2.1	PET			100 Pcs	1000	48X41X17
Color	Transparent					

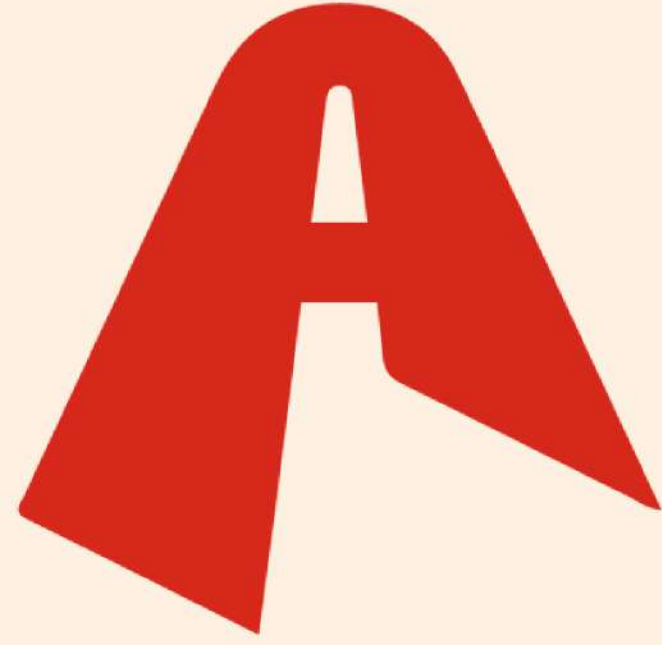

علب المايكرويف

MICROWAVABLE CONTAINERS SERIES

علب مايكرويف دائرية

8.1 Round Microwavable Containers



RC - 1 (Ø 15.5 X 3.5 cm) Cap.: 250 cc



RC1 - A (Ø 15.5 X 4.25 cm) Cap.: 375 cc



RC - 2 (Ø 15.5 X 5 cm) Cap.: 500 cc

PLASTIC MICROWAVEBLE CONTAINERS

Item No.:	Material	Capacity	Dim. Cm	Int. Packing	Pcs/Ctn	Ctn Dim.
RC-1	PP	250cc	Ø15.5X3.5	50 Pcs	200	52X33X34
RC1-A	PP	375cc	Ø15.5X4.25	50 Pcs	200	52X33X34
RC-2	PP	500cc	Ø15.5X5.0	50 Pcs	200	52X33X34
RC-3	PP	750cc	Ø18.0X4.8	50 Pcs	200	63X38X39
RC-4	PP	1000cc	Ø18.0X5.5	50 Pcs	200	63X38X39
RC-6	PP	1500cc	Ø21.4X4.8	50 Pcs	100	44X31X55
Color	Transparent		White		Black	

Note: all Containers supplied with PP microwavable Lids

علب مايكرويف دائرية

8.1 Round Microwavable Containers



RC - 3 (Ø 18 X 4.8 cm) Cap.: 750 cc



RC - 4 (Ø 18X 5.5 cm) Cap.: 1000 cc



RC - 6 (Ø 21.4 X4.8 cm) Cap.: 1500 cc

PLASTIC MICROWAVEBLE CONTAINERS

Item No.:	Material	Capacity	Dim. Cm	Int. Packing	Pcs/Ctn	Ctn Dim.
RC-1	PP	250cc	Ø15.5X3.5	50 Pcs	200	52X33X34
RC1-A	PP	375cc	Ø15.5X4.25	50 Pcs	200	52X33X34
RC-2	PP	500cc	Ø15.5X5.0	50 Pcs	200	52X33X34
RC-3	PP	750cc	Ø18.0X4.8	50 Pcs	200	63X38X39
RC-4	PP	1000cc	Ø18.0X5.5	50 Pcs	200	63X38X39
RC-6	PP	1500cc	Ø21.4X4.8	50 Pcs	100	44X31X55
Color	Transparent		White		Black	

Note: all Containers supplied with PP microwavable Lids

علب مايكرويف مستطيلة

8.2 Rectangular Microwavable Containers



C-1100 (22X15.5X4.5 cm) Cap.: 750 cc



C-1101 (22X15.5X6 cm) Cap.: 1000 cc



C-1102 (22X15.5X4.5 cm) Cap.: 2 - com

PLASTIC MICROWAVEBLE CONTAINERS						
Item No.:	Material	Capacity	Dim. Cm	Int. Packing	Pcs/Ctn	Ctn Dim.
C-1100	PP	750cc	22X15.5X4.5	50 Pcs	250	60X48X50
C-1101	PP	1000cc	22X15.5X6.0	50 Pcs	250	60X48X50
C-1102	PP	2-com	22X15.5X4.5	50 Pcs	250	60X48X50
C-1110	PP	1000cc	24.5X18.5X4.0	50 Pcs	200	60X48X50
C-1111	PP	2000cc	24.5X18.5X6.0	50 Pcs	200	60X48X50
C-1112	PP	2-com	24.5X18.5X4.0	50 Pcs	220	60X48X50
Color	Transparent		White		Black	

Note: all Containers supplied with PP microwavable Lids

علب مايكرويف مستطيلة

8.2 Rectangular Microwavable Containers



C-1110 (24.5X 18.5X4.0 cm) Cap.: 1000 cc



C-1111 (24.5X 18.5X6.0 cm) Cap.: 2000 cc



C-1112 (24.5X18.5X4.0 cm) Cap.: 2 - com

PLASTIC MICROWAVEBLE CONTAINERS

Item No.:	Material	Capacity	Dim. Cm	Int. Packing	Pcs/Ctn	Ctn Dim.
C-1100	PP	750cc	22X15.5X4.5	50 Pcs	250	60X48X50
C-1101	PP	1000cc	22X15.5X6.0	50 Pcs	250	60X48X50
C-1102	PP	2-com	22X15.5X4.5	50 Pcs	250	60X48X50
C-1110	PP	1000cc	24.5X18.5X4.0	50 Pcs	200	60X48X50
C-1111	PP	2000cc	24.5X18.5X6.0	50 Pcs	200	60X48X50
C-1112	PP	2-com	24.5X18.5X4.0	50 Pcs	220	60X48X50
Color	Transparent		White		Black	

Note: all Containers supplied with PP microwavable Lids

علب مايكرويف مستطيلة

8.3 Rectangular Microwavable Containers



C-1200 (Ø 40X16.5X4.0 cm)

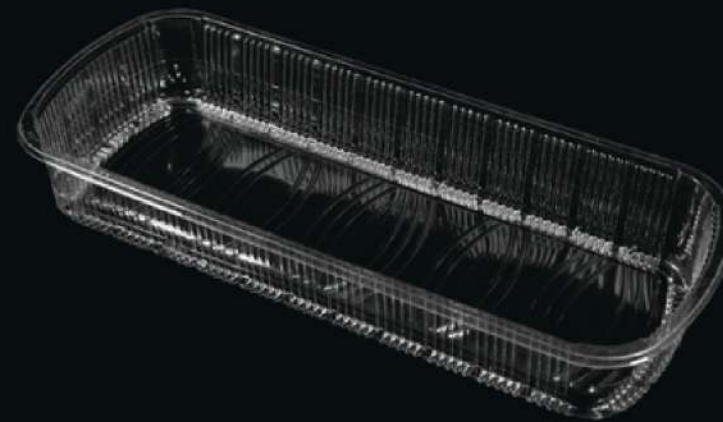

C-1201 (Ø 40X16.5X6.0 cm)



C-1202 (Ø 40X16.5X4.0 cm) 2-com

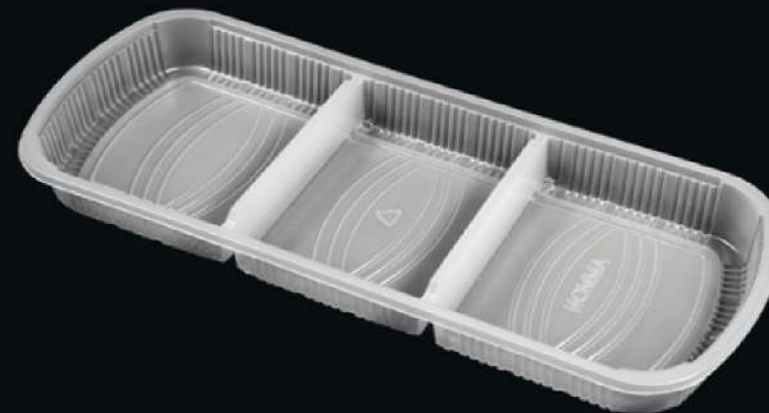

C-1203 (Ø 40X16.5X4.0 cm) 3-com

PLASTIC MICROWAVEBLE CONTAINERS

Item No.:	Material	Dim. Cm	Int. Packing	Pcs/Ctn	Ctn Dim.
C-1200	PP	40X16X4.0	25 Pcs	250	60X48X50
C-1201	PP	40X16X6.0	25 Pcs	250	60X48X50
C-1202	PP	40X16X4.0	25 Pcs	250	60X48X50
C-1203	PP	40X16X4.0	25 Pcs	250	60X48X50
C-1204	PP	40X16X4.0	25 Pcs	250	60X48X50
L-1200F	PET		50 Pcs		
F-1200D	PET		50 Pcs		
Color	Transparent	White	Black		

علب مايكرويف مستطيلة

8.3 Rectangular Microwavable Containers



C-1204 (Ø 40X16.5X4.0 cm) 4-com



L-1200F Flat Lid



F-1200D Dome Lid

PLASTIC MICROWAVEBLE CONTAINERS						
Item No.:	Material		Dim. Cm	Int. Packing	Pcs/Ctn	Ctn Dim.
C-1200	PP		40X16X4.0	25 Pcs	250	60X48X50
C-1201	PP		40X16X6.0	25 Pcs	250	60X48X50
C-1202	PP		40X16X4.0	25 Pcs	250	60X48X50
C-1203	PP		40X16X4.0	25 Pcs	250	60X48X50
C-1204	PP		40X16X4.0	25 Pcs	250	60X48X50
L-1200F	PET			50 Pcs		
F-1200D	PET			50 Pcs		
Color	Transparent		White		Black	

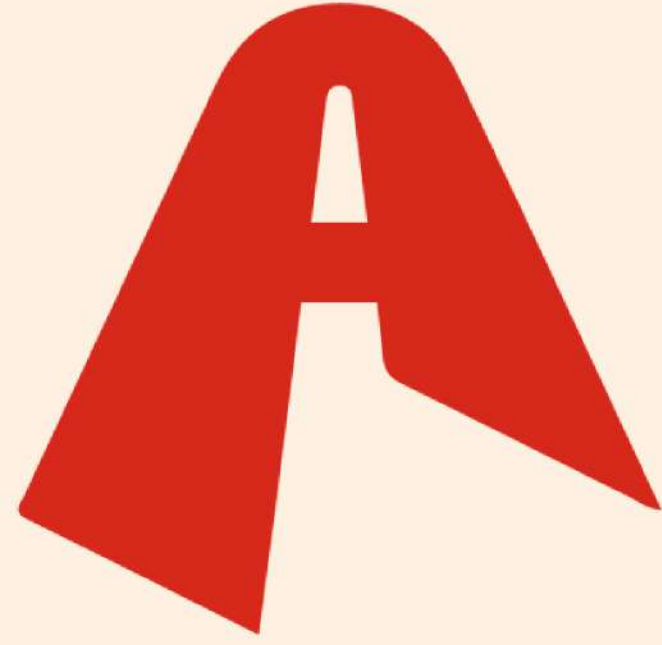

علب سوشي ووافل ومقبلات
وحلويات مع أغطية

**SUSHI, WAFFLE, APPETIZERS & SWEETS TRAYS WITH
LIDS**



علب سوشي ووافل ومقبلات وحلويات مع أغطية

9.1 SUSHI, WAFFLE, APPETIZERS & SWEETS TRAYS WITH LIDS



ST-03 (22X14X2.5 cm) Cap.: 350g



ST-04 (24X17X3 cm) Cap.: 500g



ST-08 (26.5X20X3 cm) Cap.: 750cc

Sushi, Waffle , Appetizers & Sweet Trays With Lids						
Item No.:	Material	Capacity	Dim. Cm	Int. Packing	Pcs/Ctn	Ctn Dim.
ST - 03	PS/PET	350 cc	22X14X2.5	50 Pcs	500	63X49X41
ST - 04	PS/PET	500 cc	24X17X3.0	50 Pcs	500	60X50X52
ST - 08	PS/PET	750 cc	26.5X20X3.0	50 Pcs	300	
ST - 09	PS/PET	1000cc	31X23X3.0	50 Pcs	250	
ST - 10	PS/PET	1500cc	38X27X3.0	50 Pcs	200	
ST - 11	PS/PET	1500cc	38X27X3.0	50 Pcs	200	
LST 3~11	PET					
Color	Transparent		White		Black	



علب سوشي ووافل ومقبلات وحلويات مع أغطية

9.1 SUSHI, WAFFLE, APPETIZERS & SWEETS TRAYS WITH LIDS



ST-9 (31X23X3 cm) Cap.: 1000g



ST-10 (38X27X3 cm) Cap.: 1500cc



ST-11 (42 X32X3 cm) Cap.: 2000g

Sushi, Waffle , Appetizers & Sweet Trays With Lids						
Item No.:	Material	Capacity	Dim. Cm	Int. Packing	Pcs/Ctn	Ctn Dim.
ST - 03	PS/PET	350 cc	22X14X2.5	50 Pcs	500	63X49X41
ST - 04	PS/PET	500 cc	24X17X3.0	50 Pcs	500	60X50X52
ST - 08	PS/PET	750 cc	26.5X20X3.0	50 Pcs	300	
ST - 09	PS/PET	1000cc	31X23X3.0	50 Pcs	250	
ST - 10	PS/PET	1500cc	38X27X3.0	50 Pcs	200	
ST - 11	PS/PET	1500cc	38X27X3.0	50 Pcs	200	
LST 3~11	PET					
Color	Transparent	White	Black			



علب سوشي ووافل ومقبلات وحلويات مع أغطية

9.2 SUSHI, WAFFLE, APPETIZERS & SWEETS TRAYS WITH LIDS



ST-201 (Ø 17.5X2.5 cm)



ST-203 (Ø 22.5X3 cm)



L-201



L-203

Sushi, Waffle , Appetizers & Sweet Trays With Lids						
Item No.:	Material	Capacity	Dim. Cm	Int. Packing	Pcs/Ctn	Ctn Dim.
ST-201	PS/PET		Ø 17.5X2.5	50 Pcs	500	42X42X40
ST-203	PS/PET		Ø 22.5X3	50 Pcs	500	60X35X50
L-201	PET			50 Pcs	500	60X35X50
L-201	PET			50 Pcs	500	60X48X50
Color	Transparent		Gold		Black	

علب سوشي ووافل ومقبلات وحلويات مع أغطية

9.3 SUSHI, WAFFLE, APPETIZERS & SWEETS TRAYS WITH LIDS



SR-10 (38X38X5.5 cm)



Sushi, Waffle , Appetizers & Sweet Trays With Lids						
Item No.:	Material	Capacity	Dim. Cm	Int. Packing	Pcs/Ctn	Ctn Dim.
SR -09	PS		38X38X3.5	25 Pcs	50	58.5X38.5X47.5
SR -10	PS		38X38X5.5	25 Pcs	50	58.5X38.5X47.5
SR - 11	PS		38X38X3.5	25 Pcs	50	58.5X38.5X47.5
SR - 12	PS		38X38X5.5	25 Pcs	50	58.5X38.5X47.5
SR - L	PET			50 Pcs	100	
Color	Transparent		White		Black	

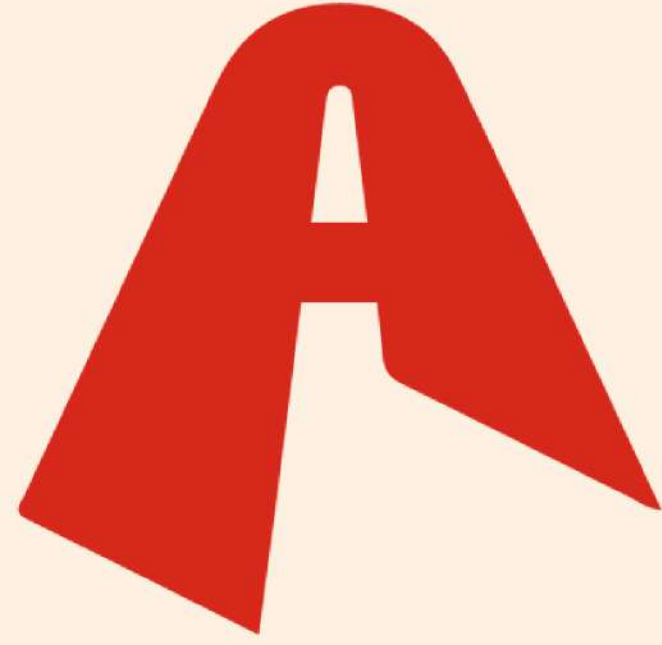

علب PET شفافة متعددة
الاستخدام

MULTY-PURPOSE PET CONTAINERS SERIES



علب PET شفافة متعددة الاستخدام

MULTY-PURPOSE PET CONTAINERS SERIES C-1000
Series



C-1000 (20X15X4,5 cm) Cap.: 1000 cc



C-1001 (20X15X4,5 cm)
Two compartment (50% / 50%)



C-1002 (20X15X4,5 cm)
Two compartment (70% / 30%)

CONTAINER WITH SEPERATE LID

Item No.:	Material	Capacity	Dim. cm	Int. Packing	Pcs/Ctn	Ctn Dim. cm
C- 1000	PET	1000cc	20X15X4.6	50 Pcs	600	58.5X38.5X47.5
C- 1001	PET	2-Com.	20X15X3.5	50 Pcs	600	58.5X38.5X47.5
C- 1002	PET	2-Com.	20X15X4.6	50 Pcs	600	58.5X38.5X47.5
C- 1003	PET	3-Com.	20X15X4.6	50 Pcs	600	58.5X38.5X47.5
C- 1004	PET	4-Com.	20X15X4.6	50 Pcs	600	58.5X38.5X47.5
C- 1005	PET	5-Com.	20X15X4.6	50 Pcs	600	58.5X38.5X47.5
C- 1006	PET	6-Com.	20X15X4.6	50 Pcs	600	58.5X38.5X47.5
L -1000	PET		20X15X4.6	50 Pcs	600	
Color	Transparent					



علب PET شفافة متعددة الاستخدام

MULTY-PURPOSE PET CONTAINERS SERIES C-1000 Series



C-1003 (20X15X4,6cm) 3-compartment

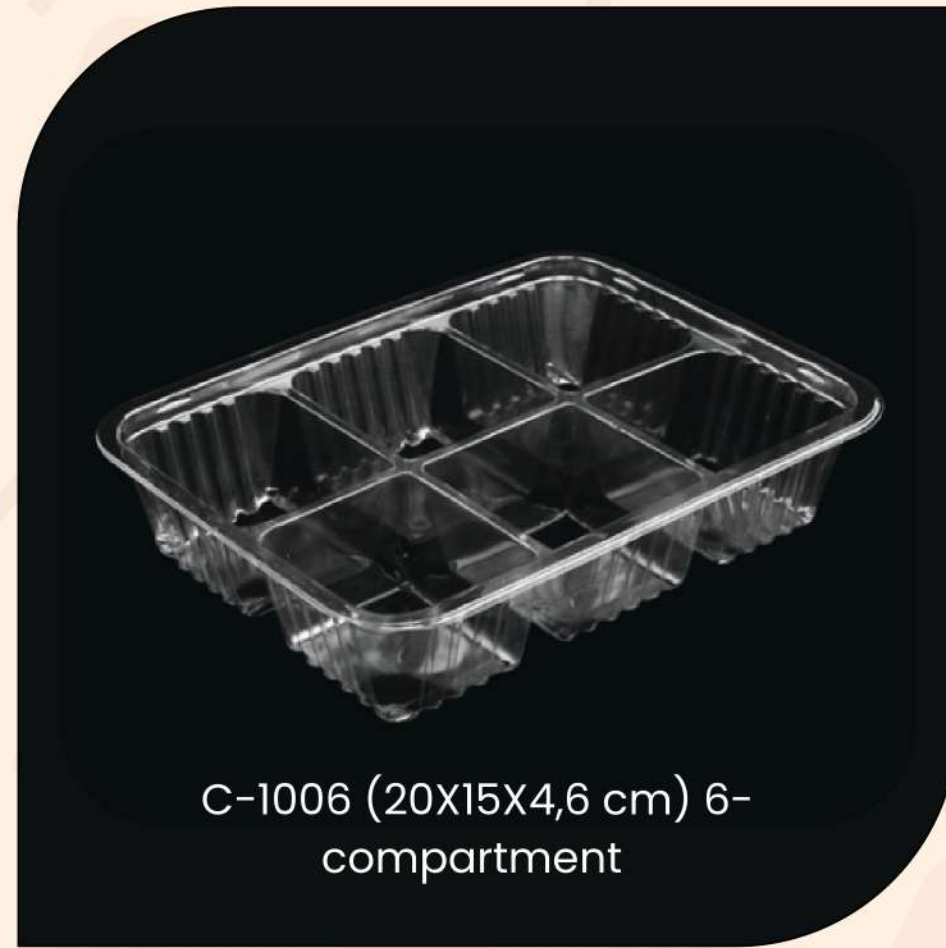

C-1006 (20X15X4,6 cm) 6-compartment



L-1000 LID

CONTAINER WITH SEPERATE LID

Item No.:	Material	Capacity	Dim. cm	Int. Packing	Pcs/Ctn	Ctn Dim. cm
C- 1000	PET	1000cc	20X15X4.6	50 Pcs	600	58.5X38.5X47.5
C- 1001	PET	2-Com.	20X15X3.5	50 Pcs	600	58.5X38.5X47.5
C- 1002	PET	2-Com.	20X15X4.6	50 Pcs	600	58.5X38.5X47.5
C- 1003	PET	3-Com.	20X15X4.6	50 Pcs	600	58.5X38.5X47.5
C- 1004	PET	4-Com.	20X15X4.6	50 Pcs	600	58.5X38.5X47.5
C- 1005	PET	5-Com.	20X15X4.6	50 Pcs	600	58.5X38.5X47.5
C- 1006	PET	6-Com.	20X15X4.6	50 Pcs	600	58.5X38.5X47.5
L -1000	PET		20X15X4.6	50 Pcs	600	
Color	Transparent					



علب PET شفافة متعددة الاستخدام MULTY-PURPOSE PET CONTAINERS SERIES C-2000 Series

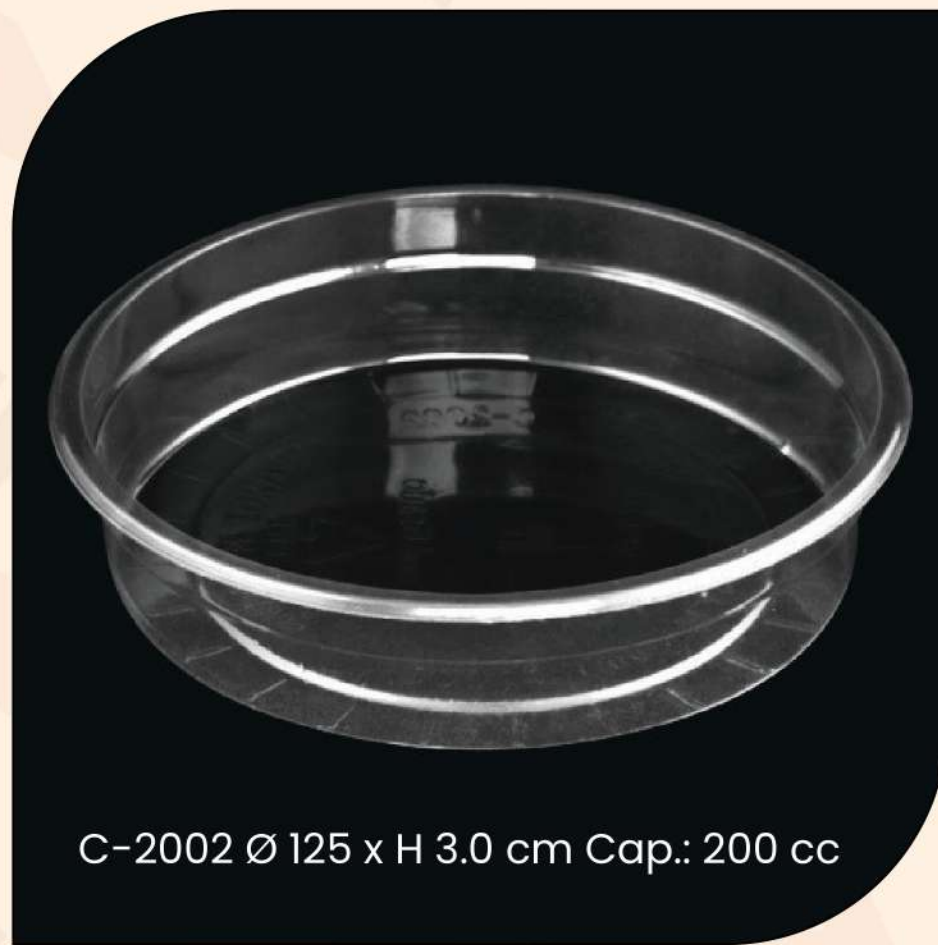

C-2002 Ø 125 x H 3.0 cm Cap.: 200 cc

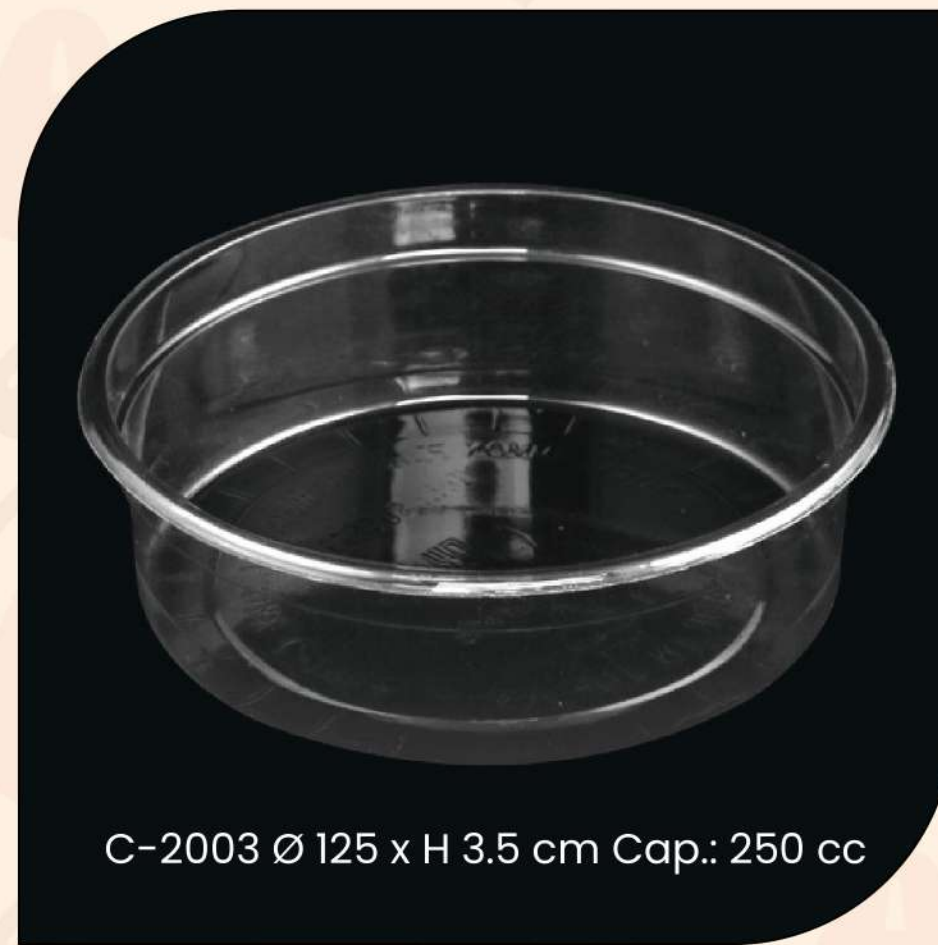

C-2003 Ø 125 x H 3.5 cm Cap.: 250 cc



C-2004 Ø 125 x H 4.5 cm Cap.: 330 cc

CONTAINER WITH SEPARAT LID

Item No.:	Material	Capacity	Dim. cm	Int. Packing	Pcs/Ctn	Ctn Dim. cm
C- 2002	PET	200 cc	Ø 12.5X3.0	50 Pcs	750	65X45X60
C- 2003	PET	250 cc.	Ø 12.5X3.5	50 Pcs	750	65X45X60
C- 2004	PET	330 cc	Ø 12.5X4.5	50 Pcs	750	65X45X60
C- 2005	PET	500 cc	Ø 12.5X6.0	50 Pcs	750	65X45X60
L- 2000	PET		Ø 13.0X1.0	100 Pcs	1500	65X45X60
Color	Transparent					

علب PET شفافة متعددة الاستخدام
MULTY-PURPOSE PET CONTAINERS SERIES C-2000
Series

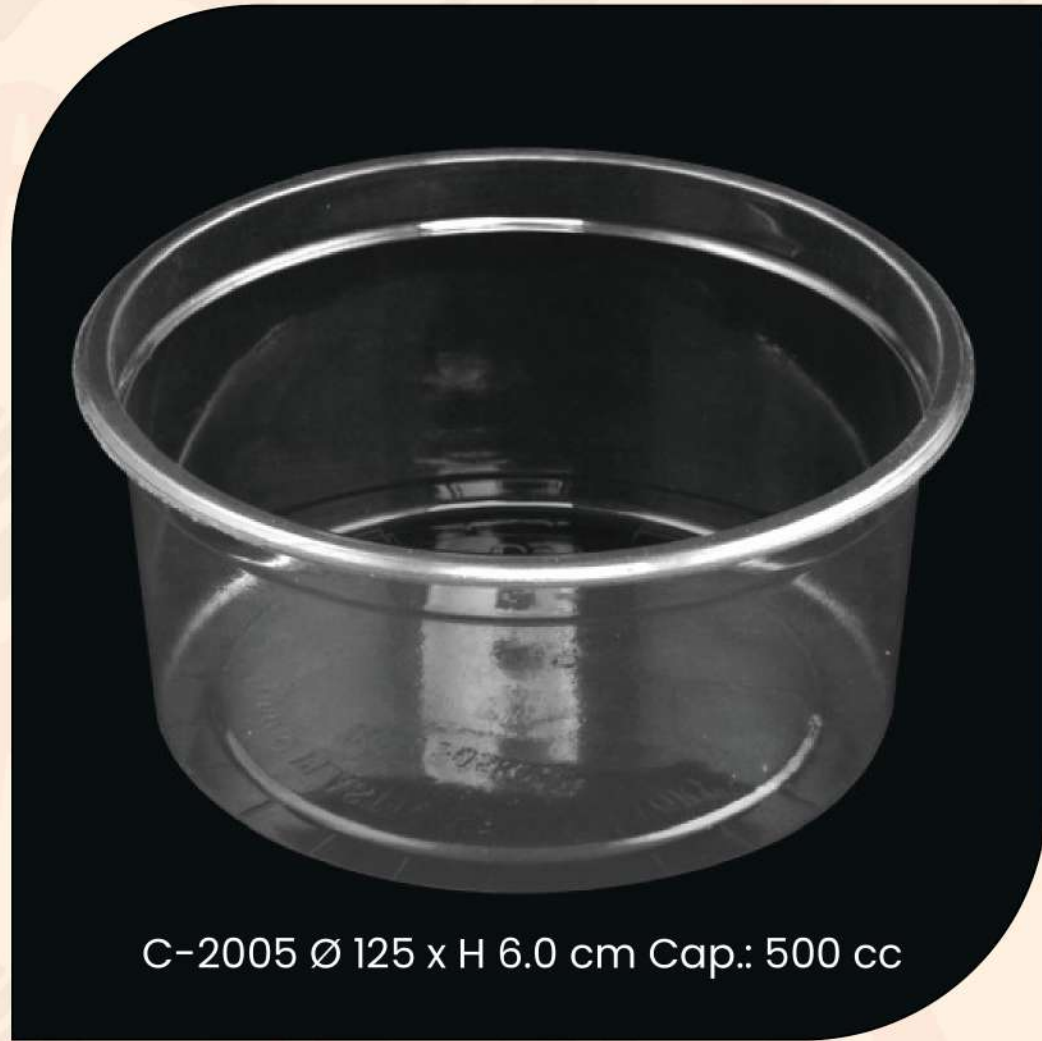

C-2005 Ø 125 x H 6.0 cm Cap.: 500 cc



L-2000 LID

CONTAINER WITH SEPARAT LID						
Item No.:	Material	Capacity	Dim. cm	Int. Packing	Pcs/Ctn	Ctn Dim. cm
C- 2002	PET	200 cc	Ø 12.5X3.0	50 Pcs	750	65X45X60
C- 2003	PET	250 cc.	Ø 12.5X3.5	50 Pcs	750	65X45X60
C- 2004	PET	330 cc	Ø 12.5X4.5	50 Pcs	750	65X45X60
C- 2005	PET	500 cc	Ø 12.5X6.0	50 Pcs	750	65X45X60
L- 2000	PET		Ø 13.0X1.0	100 Pcs	1500	65X45X60
Color	Transparent					

علبة ريزو

MULTY-PURPOSE PET CONTAINERS SERIES C-2100



C-2101 Ø 15.5 X 5.2 cm Cap.: 500cc



C-2102 Ø 15.5 X 5.2 cm Cap.: 500cc



L-2100

Customer Logo Applicable - Min . order required

CONTAINER WITH SEPARATED LID

Item No.:	Material	Capacity	Dim. cm	Int. Packing	Pcs/Ctn	Ctn Dim. cm
C-2101	PS	500 cc	Ø 15.5 X 5.2	50 Pcs	500	60X48X50
C-2102	PET	500 cc	Ø 15.5 X 5.2	50 Pcs	500	60X48X50
L-2100	PET		Ø 16.5 X 3.5	50 Pcs	500	
Color	Transparent		White		Black	

علب PET شفافة متعددة الاستخدام
MULTY-PURPOSE PET CONTAINERS SERIES CL-1004



CONTAINER WITH HINGE LID						
Item No.:	Material	Capacity	Dim. cm	Int. Packing	Pcs/Ctn	Ctn Dim. cm
CL-1004 A	PET	150 cc	12X10X2.0	50 Pcs	500	58.5X38.5X47.5
CL-1004 B	PET	200 cc.	12X10X2.5	50 Pcs	500	58.5X38.5X47.5
CL-1004 C	PET	250 cc	12X10X3.0	50 Pcs	500	58.5X38.5X47.5
CL-1004 F	PET	375 cc	12X10X4.0	50 Pcs	500	58.5X38.5X47.5
CL-1004 H	PET	450 cc	12X10X5.0	50 Pcs	500	58.5X38.5X47.5
CL-1004 K	PET	500 cc	12X10X5.5	50 Pcs	500	58.5X38.5X47.5
CL-1004 L	PET	600 cc	12X10X6.5	50 Pcs	500	58.5X38.5X47.5
Color	Transparent					

علب PET شفافة متعددة الاستخدام
MULTY-PURPOSE PET CONTAINERS SERIES CL-1004



CL- 1004 H (12X10X5cm) Cap.: 450cc



CL- 1004 K (12X10X5.5cm) Cap.: 500cc



CL- 1004 L (12X10X6.5cm) Cap.: 600cc

CONTAINER WITH HINGE LID

Item No.:	Material	Capacity	Dim. cm	Int. Packing	Pcs/Ctn	Ctn Dim. cm
CL-1004 A	PET	150 cc	12X10X2.0	50 Pcs	500	58.5X38.5X47.5
CL-1004 B	PET	200 cc.	12X10X2.5	50 Pcs	500	58.5X38.5X47.5
CL-1004 C	PET	250 cc	12X10X3.0	50 Pcs	500	58.5X38.5X47.5
CL-1004 F	PET	375 cc	12X10X4.0	50 Pcs	500	58.5X38.5X47.5
CL-1004 H	PET	450 cc	12X10X5.0	50 Pcs	500	58.5X38.5X47.5
CL-1004 K	PET	500 cc	12X10X5.5	50 Pcs	500	58.5X38.5X47.5
CL-1004 L	PET	600 cc	12X10X6.5	50 Pcs	500	58.5X38.5X47.5
Color	Transparent					



علب PET شفافة متعددة الاستخدام MULTY-PURPOSE PET CONTAINERS SERIES CL-1005



CL-1005 A (17,5X13.8X3cm) Cap.: 500cc



CL-1005 A-3 (17,5X13.8X3cm) 3- compartment



CL-1005 B (17,5X13.8X4,5cm) Cap.: 750cc



CL-1005 C (17,5X13.8X6cm) Cap.: 1000cc

CONTAINER WITH HINGE LID

Item No.:	Material	Capacity	Dim. cm	Int. Packing	Pcs/Ctn	Ctn Dim. cm
CL-1005 A	PET	500 cc	17,5X13.8X3	50Pcs	500	56X45X65
CL-1005 A-3	PET	3-Com.	17,5X13.8X3	50Pcs	500	56X45X65
CL-1005 B	PET	750 cc	17,5X13.8X4,5	50Pcs	400	56X45X65
CL-1005 C	PET	1000 cc	17,5X13.8X6	50Pcs	400	56X45X65
Color	Transparent					



علب PET شفافة متعددة الاستخدام MULTY-PURPOSE PET CONTAINERS SERIES CL-1006

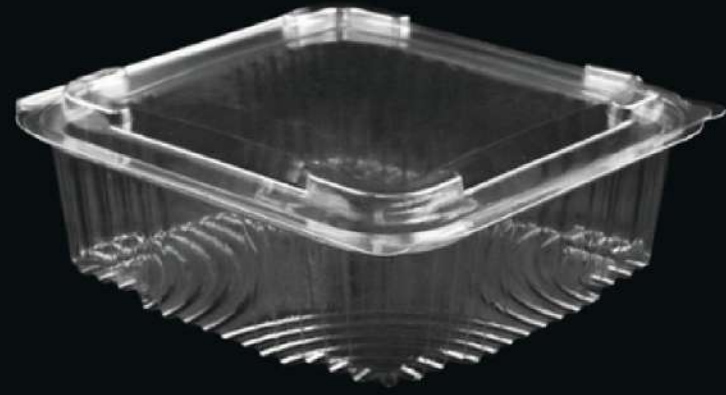

1006 A (17,5X16.5X3.0 cm) Cap.: 500 cc

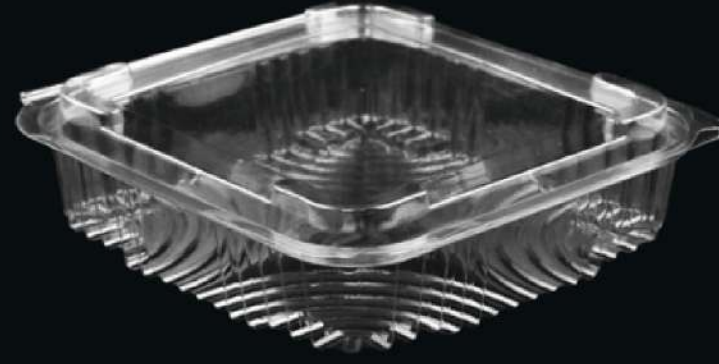

1006 B (17,5X16.5X4,0 cm) Cap.: 750 cc

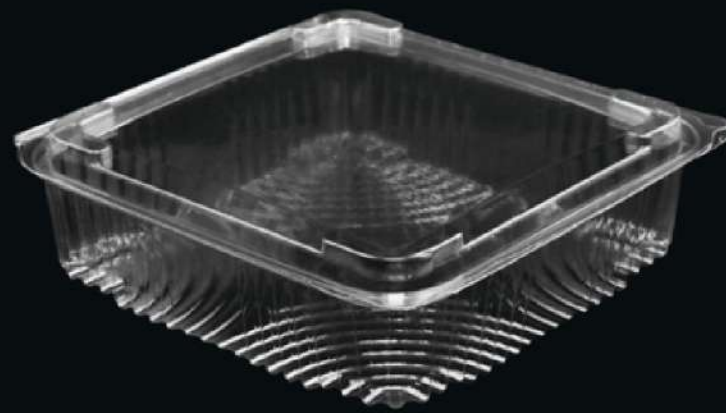

1006 C (17,5X16.5X5.5 cm) Cap.: 1000 cc

CONTAINER WITH HINGE LID

Item No.:	Material	Capacity	Dim. cm	Int. Packing	Pcs/Ctn	Ctn Dim. cm
CL-1006 A	PET	500 cc	17,5X16.5X3	50 Pcs	500	65X45X60
CL-1006 B	PET	750 cc.	17,5X16.5X4	50 Pcs	400	65X45X60
CL-1006 C	PET	1000 cc	17.5X16.5X5.5	50 Pcs	400	65X45X60
CL-1006 D	PET	1500 cc	21X20X5.5	25 Pcs	250	65X45X60
CL-1006 E	PET	2000 cc	21X20X7.0	25 Pcs	250	65X45X60
Color	Transparent					



CONTAINER WITH HINGE LID						
Item No.:	Material	Capacity	Dim. cm	Int. Packing	Pcs/Ctn	Ctn Dim. cm
CL-1006 A	PET	500 cc	17,5X16.5X3	50 Pcs	500	65X45X60
CL-1006 B	PET	750 cc.	17,5X16.5X4	50 Pcs	400	65X45X60
CL-1006 C	PET	1000 cc	17.5X16.5X5.5	50 Pcs	400	65X45X60
CL-1006 D	PET	1500 cc	21X20X5.5	25 Pcs	250	65X45X60
CL-1006 E	PET	2000 cc	21X20X7.0	25 Pcs	250	65X45X60
Color	Transparent					

علب PET شفافة متعددة الاستخدام
MULTY-PURPOSE PET CONTAINERS SERIES CL-1006



1006 A (17,5X16.5X3.0 cm) Cap.: 500 cc

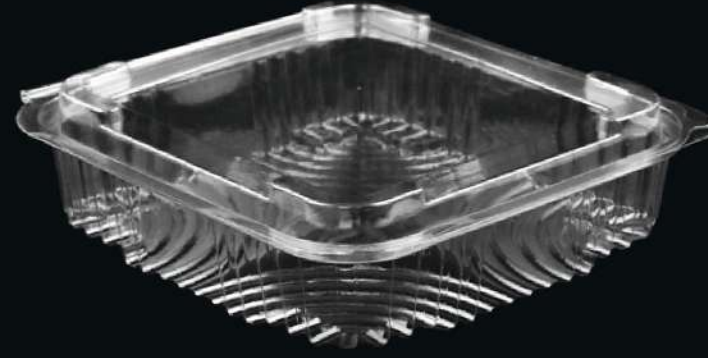

1006 B (17,5X16.5X4,0 cm) Cap.: 750 cc

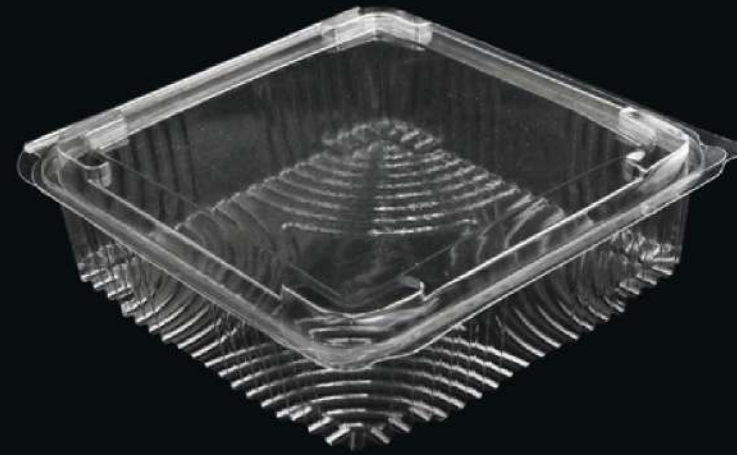

1006 C (17,5X16.5X5.5 cm) Cap.: 1000 cc

CONTAINER WITH HINGE LID

Item No.:	Material	Capacity	Dim. cm	Int. Packing	Pcs/Ctn	Ctn Dim. cm
CL-1006 A	PET	500 cc	17,5X16.5X3	50 Pcs	500	65X45X60
CL-1006 B	PET	750 cc.	17,5X16.5X4	50 Pcs	400	65X45X60
CL-1006 C	PET	1000 cc	17.5X16.5X5.5	50 Pcs	400	65X45X60
CL-1006 D	PET	1500 cc	21X20X5.5	25 Pcs	250	65X45X60
CL-1006 E	PET	2000 cc	21X20X7.0	25 Pcs	250	65X45X60
Color	Transparent					



1006 D (21.0X20.0X5,5 cm) Cap.: 1500 cc



1006 E (21.0X20.0X7 cm) Cap.: 2000 cc

CONTAINER WITH HINGE LID						
Item No.:	Material	Capacity	Dim. cm	Int. Packing	Pcs/Ctn	Ctn Dim. cm
CL-1006 A	PET	500 cc	17,5X16.5X3	50 Pcs	500	65X45X60
CL-1006 B	PET	750 cc.	17,5X16.5X4	50 Pcs	400	65X45X60
CL-1006 C	PET	1000 cc	17.5X16.5X5.5	50 Pcs	400	65X45X60
CL-1006 D	PET	1500 cc	21X20X5.5	25 Pcs	250	65X45X60
CL-1006 E	PET	2000 cc	21X20X7.0	25 Pcs	250	65X45X60
Color	Transparent					



علب PET شفافة متعددة الاستخدام MULTY-PURPOSE PET CONTAINERS SERIES CL-1006



CL-1008 B (21X15X3cm) Cap.: 750 cc



CL-1008 B/5 (21X15X3cm) 5- compartment



CL-1008 C (21X15X5cm) Cap.: 1000 cc

Container With Hinge Lid

Item No.:	Material	Capacity	Dim. cm	Int. Packing	Pcs/Ctn	Ctn Dim. cm
CL-1008 B	PET	750 cc	21X15X3	25Pcs	400	65X45X60
CL-1008B/5	PET	5-Com	21X15X3	25 Pcs	400	65X45X60
CL-1008 C	PET	1000 cc	21X15X5	25 Pcs	400	65X45X60
CL-1008 D	PET	1500 cc	21X15X6	25 Pcs	250	55X45X56
CL-1008 E	PET	2000 cc	21X15X9	25 Pcs	250	55X45X56
Color	Transparent					

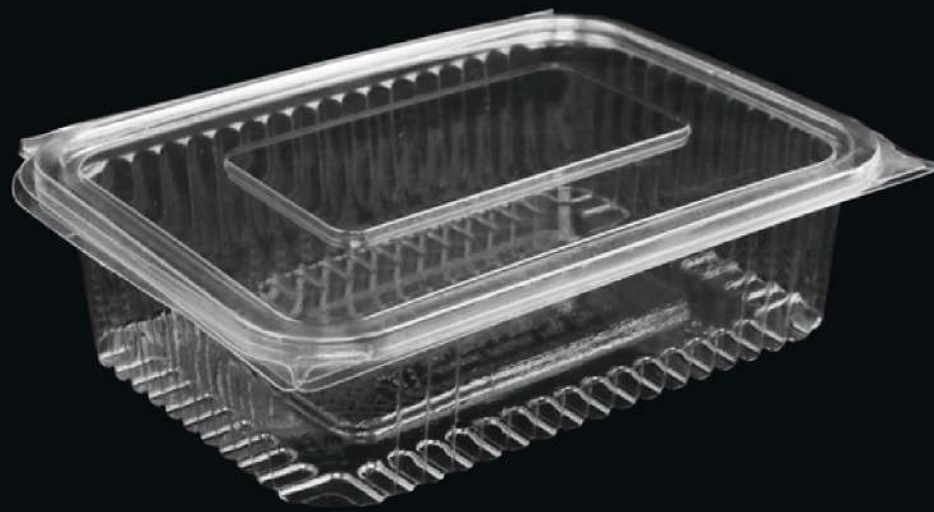

CL-1008 D (21X15X6cm) Cap.: 1500 cc



CL-1008 E (21X15X9cm) Cap.: 2000 cc

Container With Hinge Lid						
Item No.:	Material	Capacity	Dim. cm	Int. Packing	Pcs/Ctn	Ctn Dim. cm
CL-1008 B	PET	750 cc	21X15X3	25Pcs	400	65X45X60
CL-1008B/5	PET	5-Com	21X15X3	25 Pcs	400	65X45X60
CL-1008 C	PET	1000 cc	21X15X5	25 Pcs	400	65X45X60
CL-1008 D	PET	1500 cc	21X15X6	25 Pcs	250	55X45X56
CL-1008 E	PET	2000 cc	21X15X9	25 Pcs	250	55X45X56
Color	Transparent					

علب PET شفافة متعددة الاستخدام
MULTY-PURPOSE PET CONTAINERS SERIES B 1000 -
3000 Series



B - 1203 (20X15X4,5 cm) Donuts Box



B -1303 (18X15X13 cm) Croissants Box

BAKERY SERIES BOXES						
Item No.:	Material	Capacity	Dim. cm	Int. Packing	Pcs/Ctn	Ctn Dim. cm
B - 1103	PET		23.5X16.5X10		600	
B - 1106	PET		23.5X16.5X9	50 Pcs	600	
B -1203	PET		29X19X10	25 Pcs	125	58X38X47
B - 1303	PET		18X15X10	50 Pcs	600	
Color	Transparent					



علب PET شفافة متعددة الاستخدام

MULTY-PURPOSE PET CONTAINERS SERIES B 1000 -
3000 Series

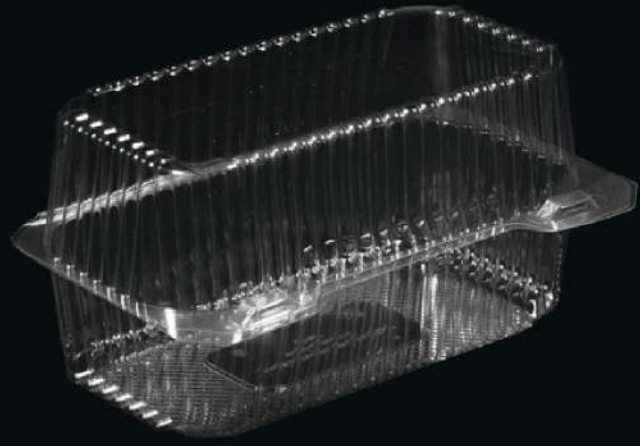

B - 1403 (19X10X10.5 cm) Cake Box

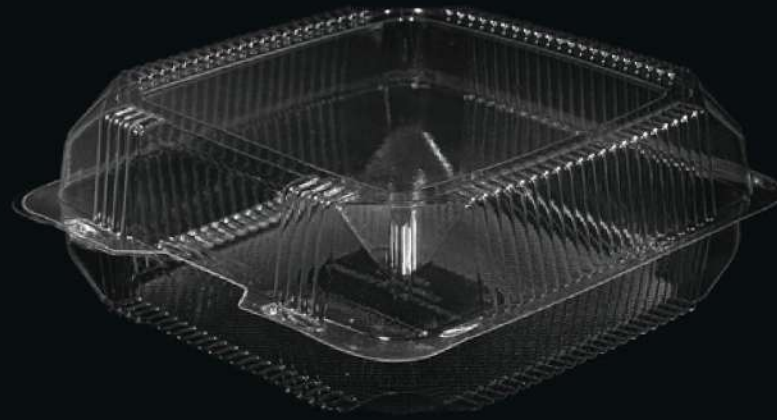

B - 3303 (20.5X20.5X8 cm) Cake Box

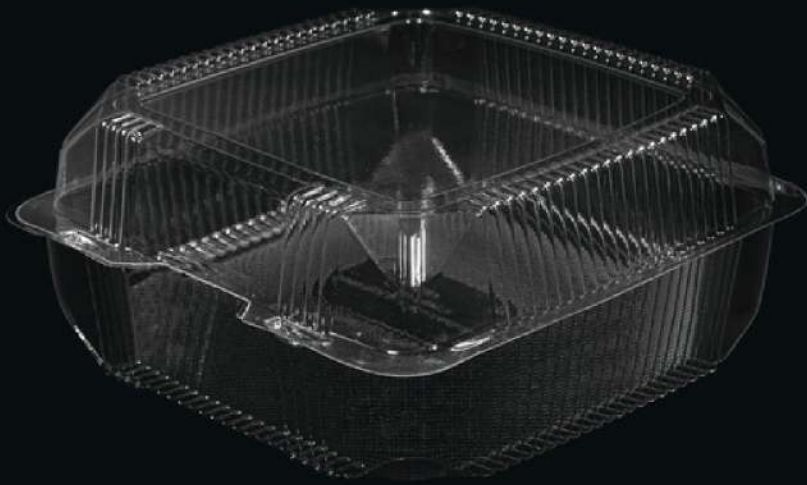

B - 3305 (20.5X20.5X11cm) Cake Box

BAKERY SERIES BOXES

Item No.:	Material	Capacity	Dim. cm	Int. Packing	Pcs/Ctn	Ctn Dim. cm
B-1403	PET		19.0X10.0X10.5	50 Pcs	250	55X45X55
B-3303	PET		20.5X20.5X8	25 Pcs	250	65X45X56
B-3305	PET		20.5X20.5X11	25 Pcs	250	65X45X56
Color	Transparent					



HB - 1 (15X15X9 cm) Burger Box



HD - 1 (21X8.5X8 cm) Sandwich Box-Small



HD - 2 (25X8.5X8 cm)
Sandwich Box-Medium

SANDWICHES BOXES						
Item No.:	Material	Dim. cm	Int. Packing	Pcs/Ctn	Ctn Dim. cm	
HB - 1	PET	15X15X9	50 Pcs	500	60X48X50	
HD - 1	PET	21X8.5X8	50 Pcs	350	58X38X47	
HD - 2	PET	25X8.5X8	50 Pcs	400	58X38X47	
CS - 1	PET	17X6X8	100 Pcs	1000	60X45X62	
Color	Transparent					

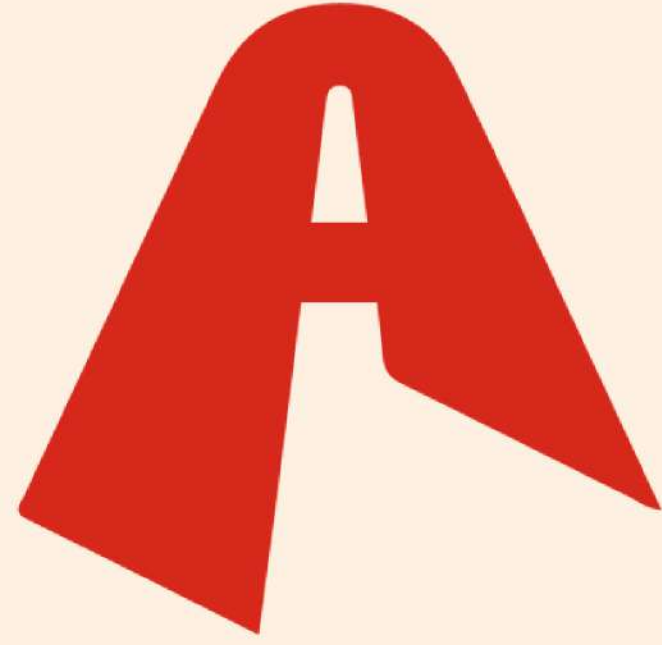

كاسات وأغطية شفافة

PET CUPS & LIDS SERIES

كاسات عصير
(Drinks Cups) DC Series

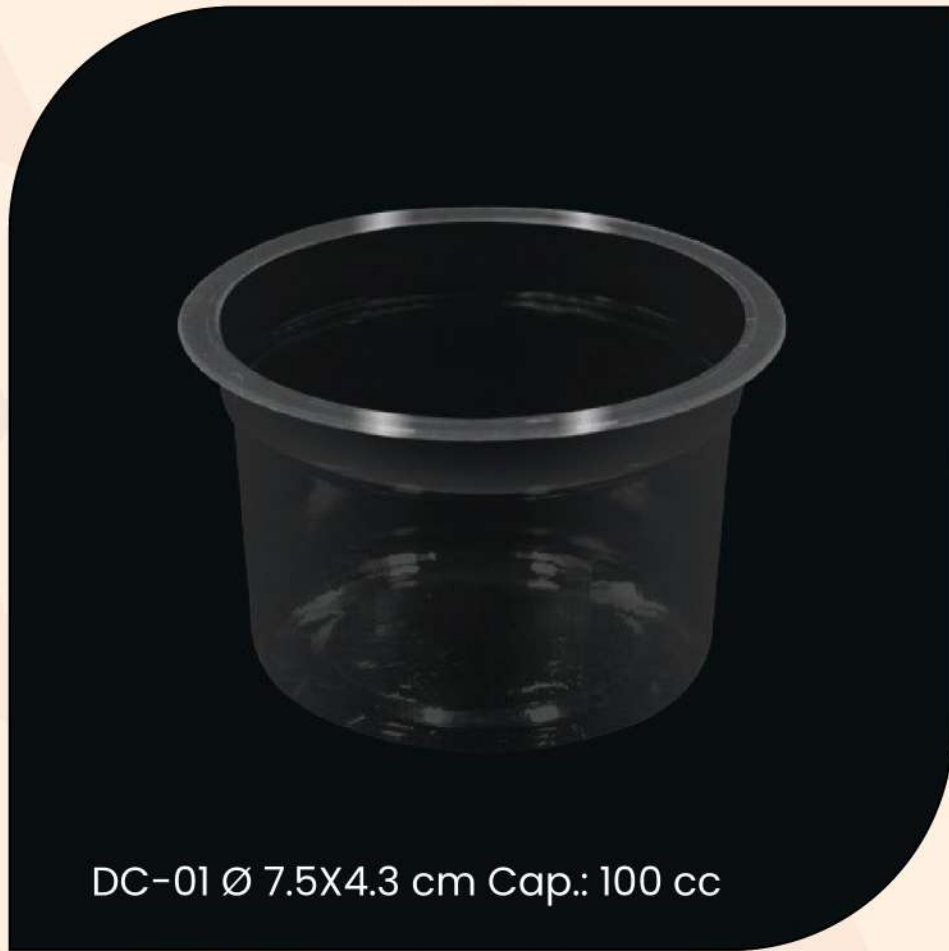

DC-01 Ø 7.5X4.3 cm Cap.: 100 cc



DC-02 Ø 7.5X6.5 cm Cap.: 150 cc



DC-03 Ø 7.5X8.5 cm Cap.: 200 cc

CUPS & LIDS						
Item No.:	Material	Capacity	Dim. Cm	Int. Packing	Pcs/Ctn	Ctn Dim.
DC - 01	PET	100 cc	Ø 7.5X4.3	50 Pcs	2500	65X45X60
DC - 02	PET	150 cc.	Ø 7.5X6.2	50 Pcs	2500	65X45X60
DC - 03	PET	200 cc	Ø 7.5X8.5	50 Pcs	2500	65X45X60
DC - 04	PET	250 cc	Ø 7.5X10	50 Pcs	2500	65X45X60
FLDC-01-04	PET	FLat	Ø 7.5	100 Pcs	2500	42X42X40
DLDC-01-04	PET	Dome	Ø 7.5	100 Pcs	2500	42X42X40
Color	Transparent					

كاسات عصير
(Drinks Cups) DC Series



DC-04 Ø 7.5X10 cm Cap.: 250 cc

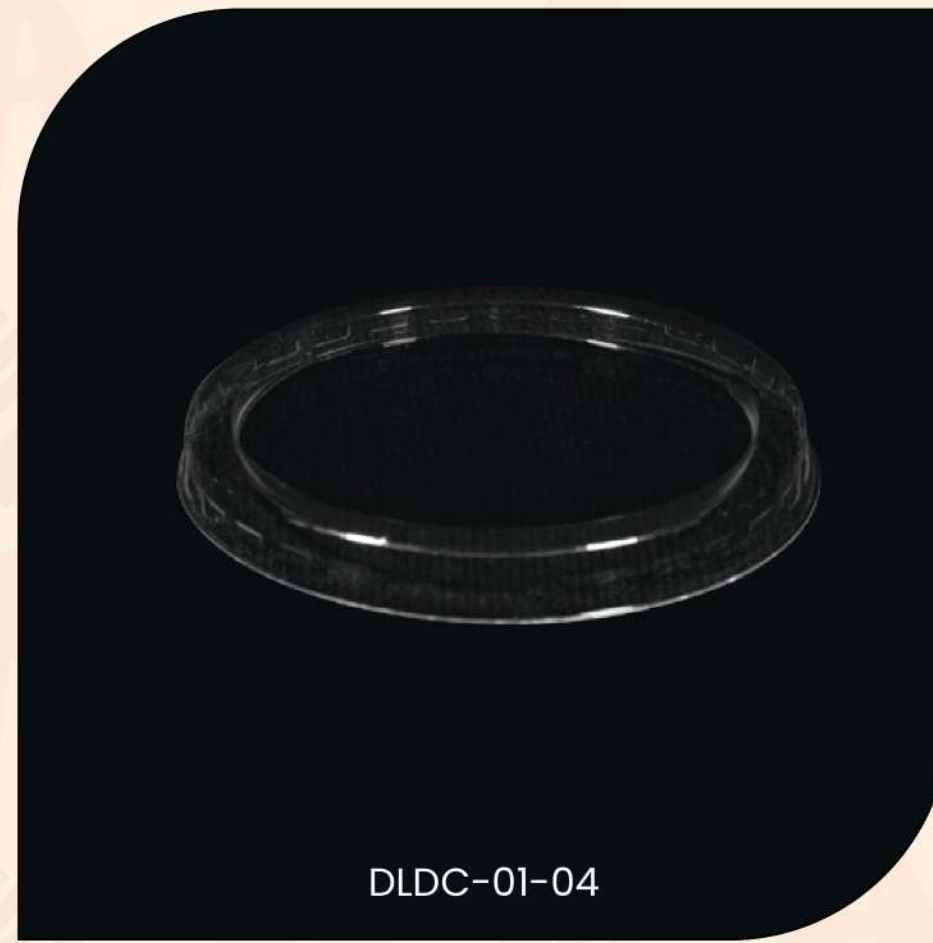

DLDC-01-04



FLDC-01-04

CUPS & LIDS

Item No.:	Material	Capacity	Dim. Cm	Int. Packing	Pcs/Ctn	Ctn Dim.
DC - 01	PET	100 cc	Ø 7.5X4.3	50 Pcs	2500	65X45X60
DC - 02	PET	150 cc.	Ø 7.5X6.2	50 Pcs	2500	65X45X60
DC - 03	PET	200 cc	Ø 7.5X8.5	50 Pcs	2500	65X45X60
DC - 04	PET	250 cc	Ø 7.5X10	50 Pcs	2500	65X45X60
FLDC-01-04	PET	FLat	Ø 7.5	100 Pcs	2500	42X42X40
DLDC-01-04	PET	Dome	Ø 7.5	100 Pcs	2500	42X42X40
Color	Transparent					

كاسات كوكتيل
(Cocktail Cups) CC Series



CC-10 Ø 80X10 cm Cap.: 10 OZ



CC-12 Ø 92X10 cm Cap.: 12 OZ



CC-14 Ø 92X10.5 cm Cap.: 14 OZ

CUPS & LIDS

Item No.:	Material	Capacity	Dim. Cm	Int. Packing	Pcs/Ctn	Ctn Dim.
CC - 10	PET	10 oz	Ø 80X10	50 Pcs	1000	48X38X34.5
CC - 12	PET	12 oz	Ø 92X10	50 Pcs	1000	48X39X45
CC - 14	PET	14 oz	Ø 92X10.5	50 Pcs	1000	48X39X45
CC - 16	PET	16 oz	Ø 92X12	50 Pcs	1000	48X39X45
FLDC-10-16	PET	FLat		100 Pcs	1000	
DLDC-10-16	PET	Dome		100 Pcs	1000	
Color	Transparent					

كاسات كوكتيل
(Cocktail Cups) CC Series



CC-16 Ø 92X12 cm Cap.: 16 OZ



FLCC-10-16



DLCC-10-16

CUPS & LIDS						
Item No.:	Material	Capacity	Dim. Cm	Int. Packing	Pcs/Ctn	Ctn Dim.
CC - 10	PET	10 oz	Ø 80X10	50 Pcs	1000	48X38X34.5
CC - 12	PET	12 oz	Ø 92X10	50 Pcs	1000	48X39X45
CC - 14	PET	14 oz	Ø 92X10.5	50 Pcs	1000	48X39X45
CC - 16	PET	16 oz	Ø 92X12	50 Pcs	1000	48X39X45
FLDC-10-16	PET	FLat		100 Pcs	1000	
DLDC-10-16	PET	Dome		100 Pcs	1000	
Color	Transparent					

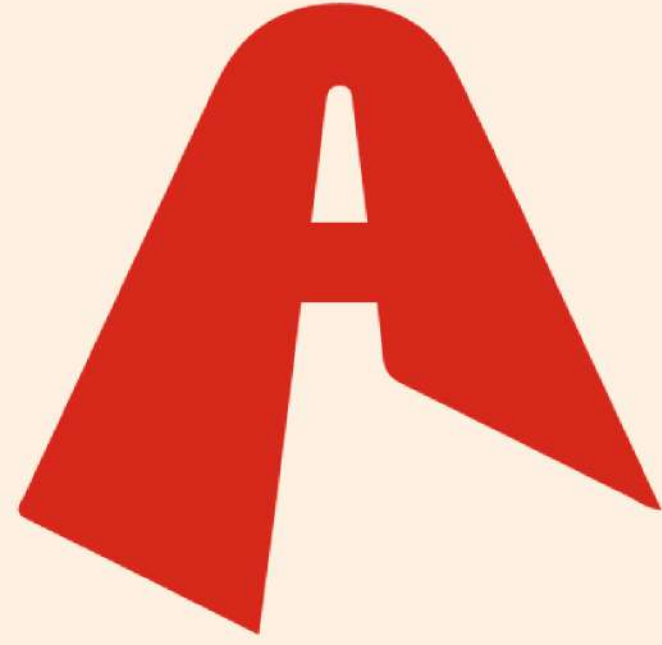

علب طوص وتتبيلة ومايونيز

SAUSE CUPS & LIDS

علب طوص وتتبيلة ومايونيز
12.1 Sause Cups & Lids

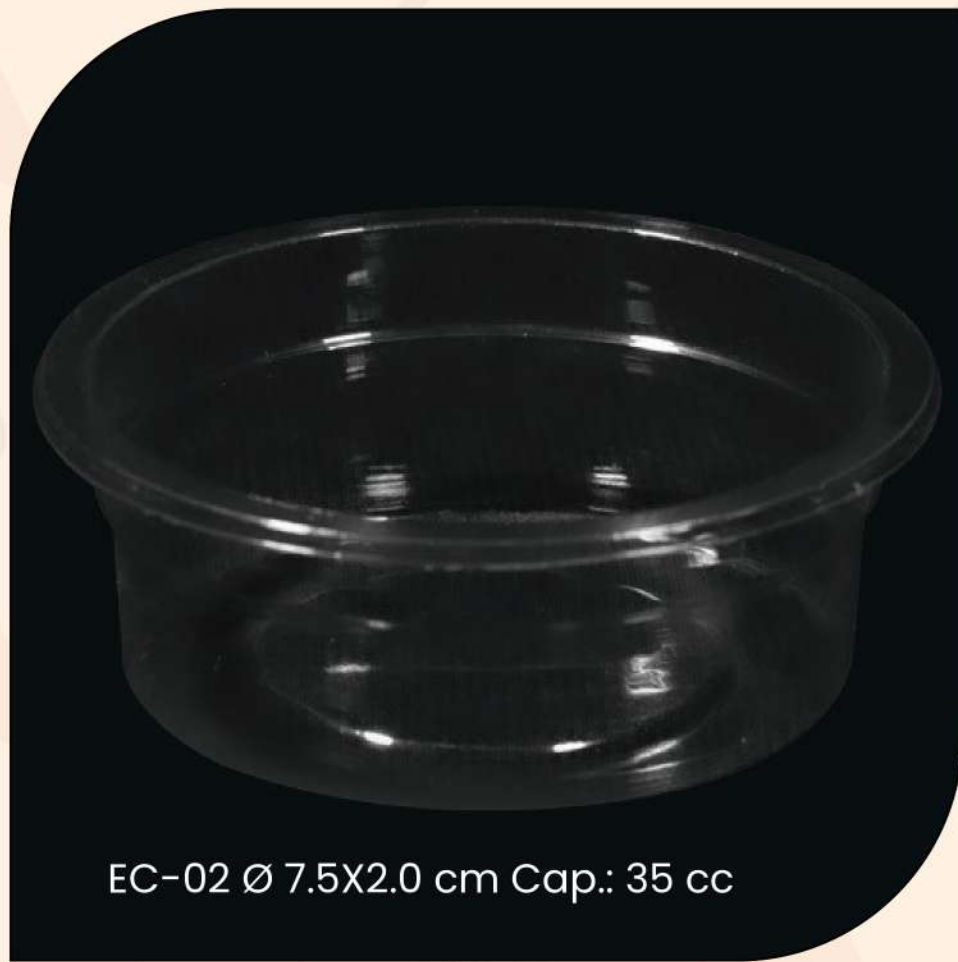

EC-02 Ø 7.5X2.0 cm Cap.: 35 cc

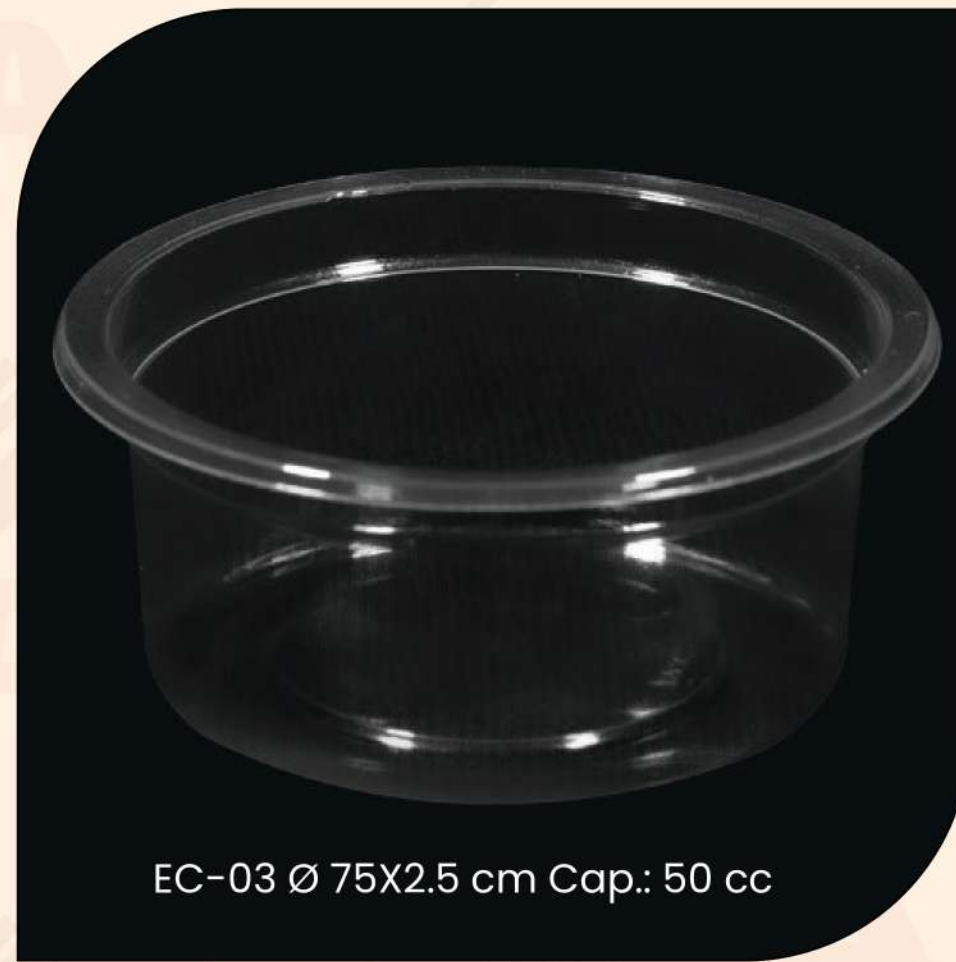

EC-03 Ø 7.5X2.5 cm Cap.: 50 cc



EC-04 Ø 7.5X3.5 cm Cap.: 75 cc

Sause Cups & Lids						
Item No.:	Material	Capacity	Dim. Cm	Int. Packing	Pcs/Ctn	Ctn Dim.
EC-02	PET	35 cc	Ø 7.5X2.0	50 Pcs	2500	60X52X38
EC-03	PET	50 cc	Ø 7.5X2.5	50 Pcs	2500	60X52X38
EC-04	PET	75 cc	Ø 7.5X3.5	50 Pcs	2500	60X52X38
EC-05	PET	100 cc	Ø 7.5X4.3	50 Pcs	2500	60X52X38
Flat or Dome Lid	PET			2500 Pcs	2500	42X42X40
Color	Transparent			Black		

علب طوص وتتبيلة ومايونيز
12.1 Sause Cups & Lids



EC-05 Ø 7.5X4.3 cm Cap.: 100 cc

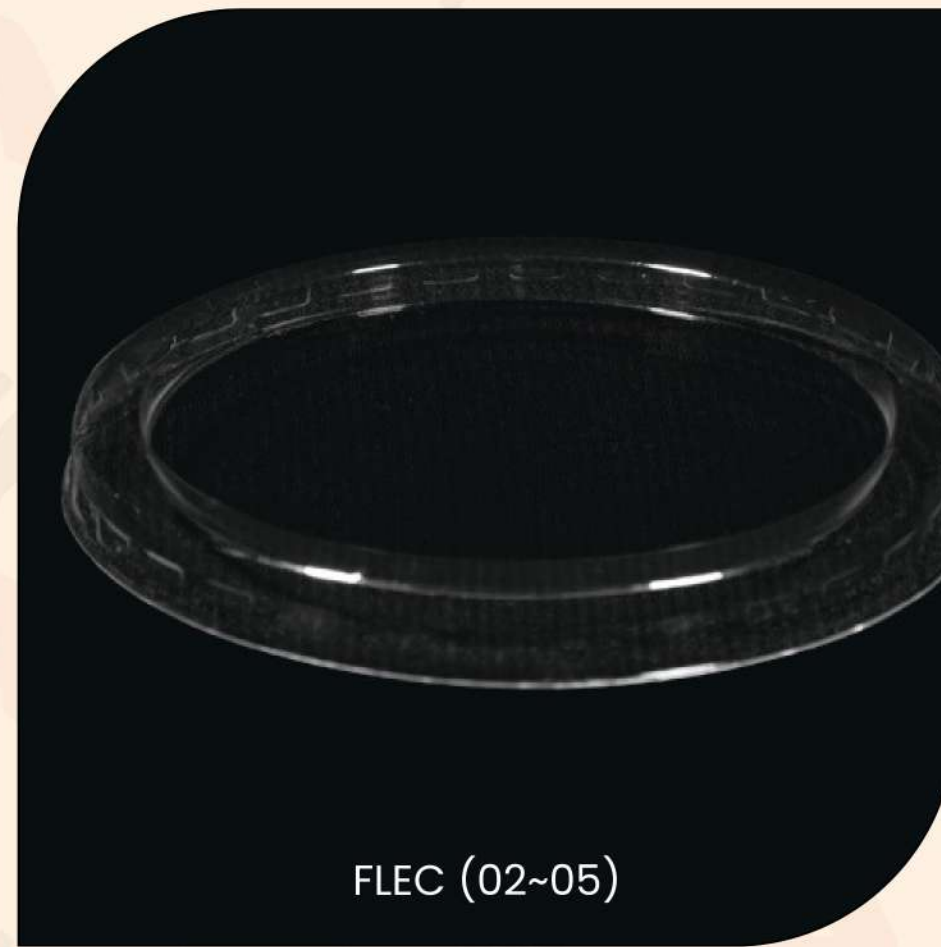

FLEC (02~05)



DLEC (02~05)

Sause Cups & Lids						
Item No.:	Material	Capacity	Dim. Cm	Int. Packing	Pcs/Ctn	Ctn Dim.
EC-02	PET	35 cc	Ø 7.5X2.0	50 Pcs	2500	60X52X38
EC-03	PET	50 cc	Ø 7.5X2.5	50 Pcs	2500	60X52X38
EC-04	PET	75 cc	Ø 7.5X3.5	50 Pcs	2500	60X52X38
EC-05	PET	100 cc	Ø 7.5X4.3	50 Pcs	2500	60X52X38
Flat or Dome Lid	PET			2500 Pcs	2500	42X42X40
Color	Transparent			Black		

علب طوص وتتيلة ومايونيز
12.2 Sause Cups & Lids



12.2.1 Ø 6.5X2.2 cm Cap.: 1.5 oz



12.2.2 Ø 6.5X3.0 cm Cap.: 2 oz



12.2.3 Ø 7.5X2.2 cm Cap.: 3 oz

Sause Cups & Lids						
Item No.:	Material	Capacity	Dim. Cm	Int. Packing	Pcs/Ctn	Ctn Dim.
12.2.1	PET	1.5 oz	Ø 6.5X2.2	100 Pcs	2000	32X32X26.5
12.2.2	PET	2 oz	Ø 6.5X3.0	100 Pcs	2000	32X32X26.5
12.2.3	PET	3 oz	Ø 7.5X3.5	50 Pcs	2500	60X52X40
12.2.4	PET	4 oz	Ø 7.5X4.3	50 Pcs	2500	60X52X40
Lid 1.5 ~ 2 oz	PET			100 Pcs	2000	38X34X28.0
Lid 3 ~ 4 oz	PET			100 Pcs	2500	42X42X40
Color	Transparent			Black		



12.2.4 Ø 6.5X3.0 cm Cap.: 4 oz



LID (01~04)

Sause Cups & Lids						
Item No.:	Material	Capacity	Dim. Cm	Int. Packing	Pcs/Ctn	Ctn Dim.
12.2.1	PET	1.5 oz	Ø 6.5X2.2	100 Pcs	2000	32X32X26.5
12.2.2	PET	2 oz	Ø 6.5X3.0	100 Pcs	2000	32X32X26.5
12.2.3	PET	3 oz	Ø 7.5X3.5	50 Pcs	2500	60X52X40
12.2.4	PET	4 oz	Ø 7.5X4.3	50 Pcs	2500	60X52X40
Lid 1.5 ~ 2 oz	PET			100 Pcs	2000	38X34X28.0
Lid 3 ~ 4 oz	PET			100 Pcs	2500	42X42X40
Color	Transparent			Black		

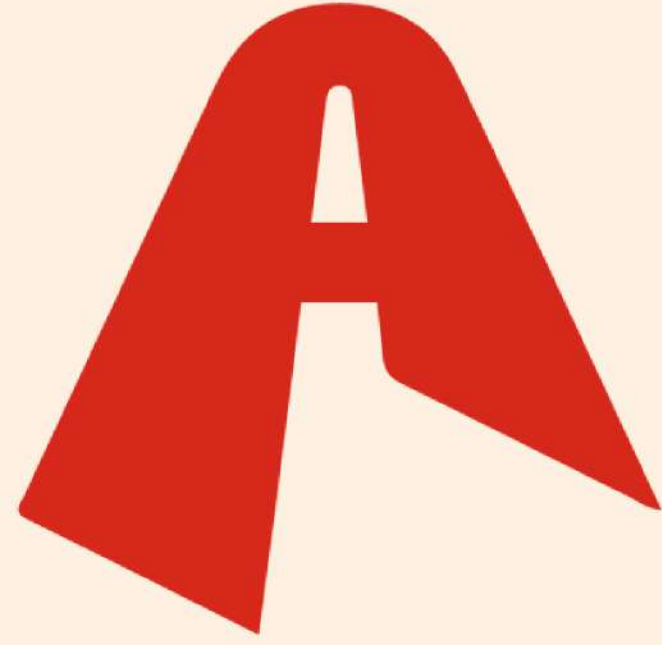

الشلمونات
Straws



Straws					
Item No.	Descin	Straw Dim. HØX mm	Pcs/Bag	Qty/Ctn Pcs	Ctn Dim. Cm
13.1.1	Medium Duty Straw	210X6.0	1000	10000	120X21X45
13.1.2	Heavy Duty Straw Prepacked	210X6.0	250	10000	55X55X45
13.1.3	Heavy Duty Straw 8 mm	210X8.0	300	6600	55X55X45
13.1.4	Heavy Duty Straw 10 mm	210X10	300	8100	55X55X45
13.1.5	Heavy Duty Straw 12 mm	210X12	300	5100	55X55X45
13.1.6	8 mm Straws Prepacked	210X8.0	200	4000	45X48X48
13.1.7	10 mm Straws Prepacked	210X10	200	4000	45X48X48
13.1.8	12 mm Straws Prepacked	210X12	200	4000	45X48X48
13.1.9	Flexible Straws 6mm Prepacked	210X6.0	250	10000	45X48X48
13.2.1	Flexible Crazy Straws 6 mm	260X6.0	100	4000	50X33.5X29

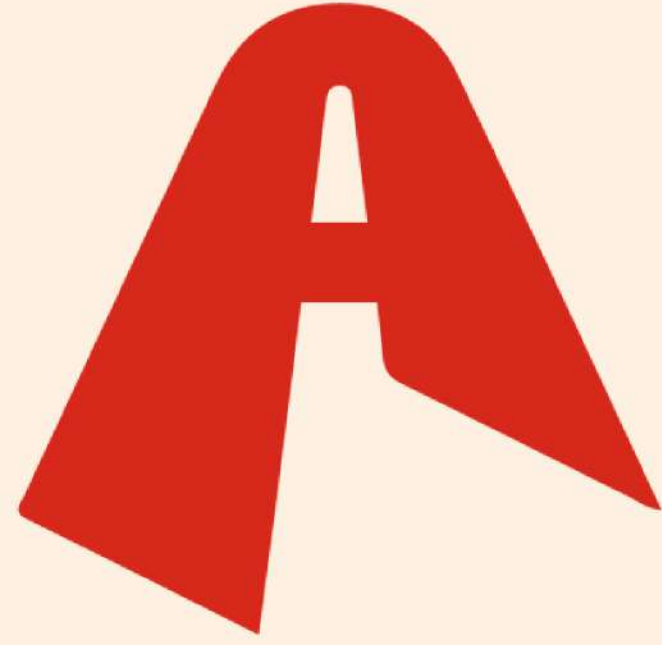

منتوجات صحية - مستهلكات

Disposable Hygienic Products



- | | |
|---------------------------|-----------------------|
| 1. PE Gloves | - 1 كفوف نايلون خفيفه |
| 2. Vinyle Gloves | - 2 كفوف فانيل |
| 3. Latex & Nitrile Gloves | - 3 كفوف للاتيكس كفوف |
| 4. Long Sleeve Gloves | - 4 طويله |
| 5. Industrial Gloves | - 5 كفوف صناعية كفوف |
| 6. Oven Gloves | - 6 حراريه |
| 7. Arm Sleeve | - 7 ارم سليف |
| 8. Masks | - 8 كمامات |
| 9. Nurse Cap | - 9 غطاء رأس |
| 10. Shoes Cap | - 10 غطاء قدم |
| 11. Aprons | - 11 مريول نايلون |

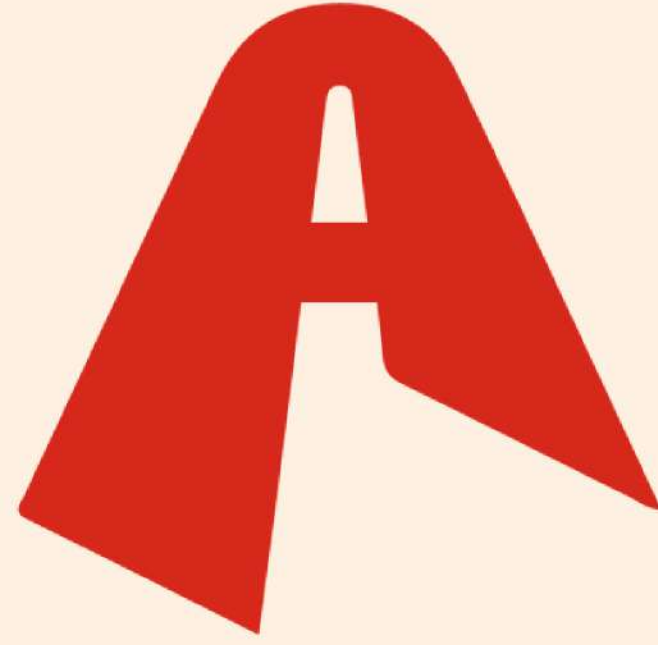

منتوجات ورقية وكرتونية

Paper Products & Supply



1. Pizza Boxes
 2. Fast Food Trays & Boxes
 3. Paper Cups
 4. Paper Cup Holdes
 5. Carton Trays
 6. Cake Bases
 7. Chif Hat & Waitress Boat Hat
 8. Different types of tissue paper
 9. Different types of Sandwiches wrapping Paper
 10. Paper Bags in various sizes
 11. Sweets Wrapping Paper Rolls
- * Printing Customer Logo is applicale on all paper products - minimum quantity required

- 1 علب البيتزا
- 2 علب وصحون الوجبات السريعه
- 3 كاسات ورقيه متنوعه
- 4 قواعد كاسات المشروبات
- 5 جاطات كرتونيه بانواعها
- 6 قواعد كيك كرتونية
- 7 طواقى القارب وطواقى الشيف
- 8 ورق صحي لجميع الالاستخدامات
- 9 ورق الساندويش بانواعه
- 10 اكياس الورق بجميع احجامها
- 11 روللات لف الحلويات
- * امكانية الطباعة الخاصة على المنتجات الورقيه

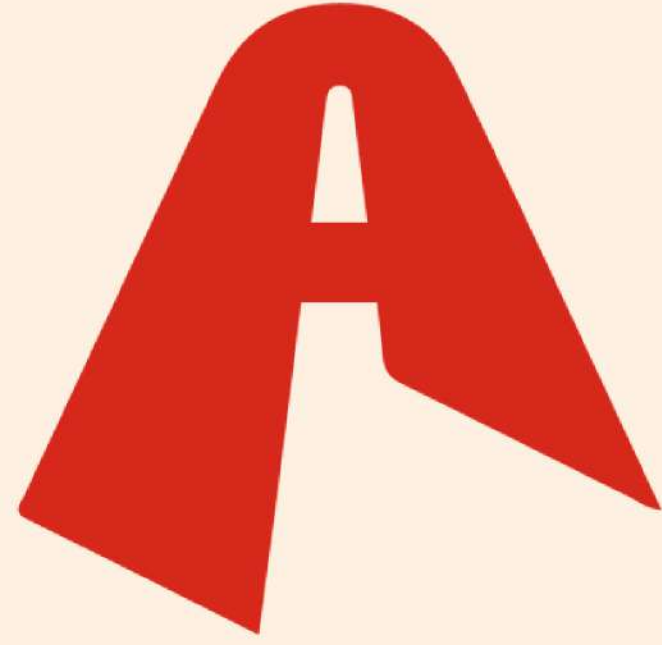

أدوات مواد التنظيف

Cleaning Products & Cleaning Materials



- 1- Housekeeping Cleaning Agents
- 2- Housekeeping Cleaning Equipments
- * Floor & Windows Wipers
- * Brooms
- * Cleaning Cloths & Cotton Wipers and Mops
- * Cleaning Sponge & Absorbent Pads
- * Floor & Grill Brushes
- * Trash Cans
- * Disposable Ashtrays

- 1 مواد التنظيف الكيماوية بأنواعها
- 2 ادوات التنظيف
- * قشطات الأرض والزجاج
- * مكائس بأنواعها
- * فوط التنظيف وامماسح الأرض
- * اسفنجة الجلي وسلطة الجلي
- * فراشي الأرض والسلك
- * سلالات وحوايات القمامة
- * منفضة السجائر المستهلكة

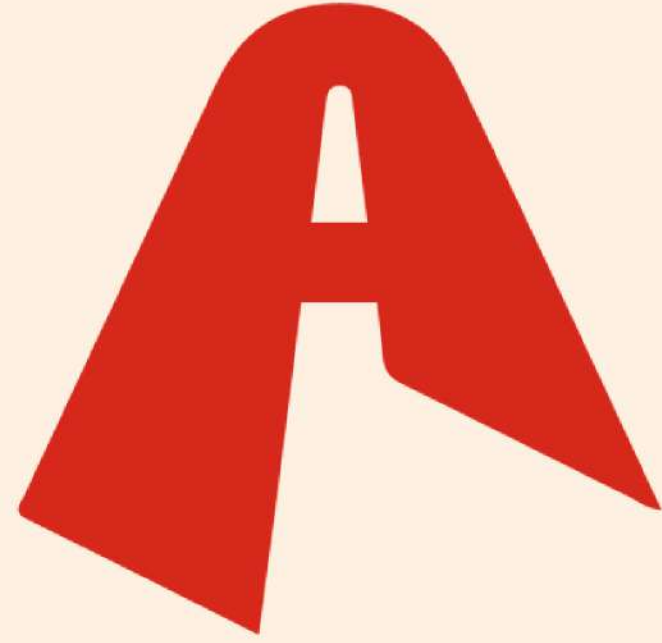

أكياس التسوق والتفريز والنفايات

B a g s



1- Shopping Bags

2- Freeze Bags

3- Zipper Bags

4- Garbage Bags

1 - أكياس تسوق

2 - أكياس تفریز

3 - أكياس مع إغلاق ذاتي

4 - أكياس القمامة بأشكالها

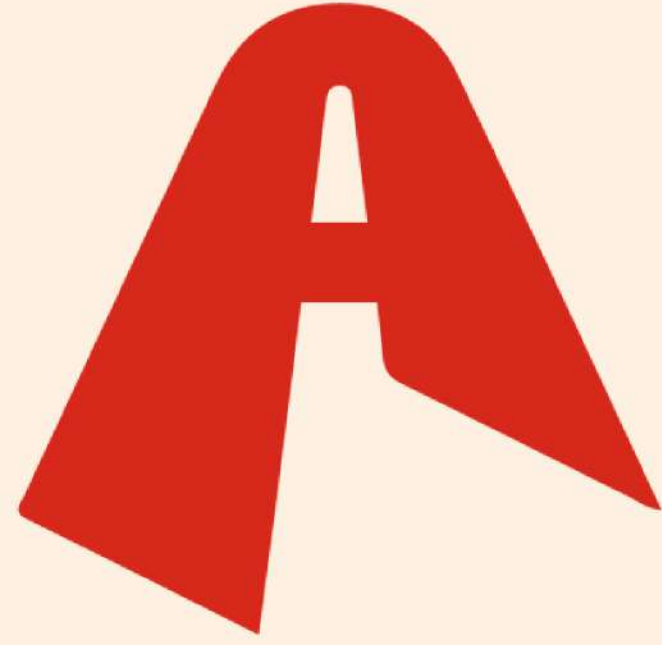

رولات تغليف
Wrapping Products



1- Cling Wrap Film

2- Aluminum Foil

3- Stretch Roll

4- Bubble Wrap Roll

1 - رولات تغليف النايلون

2 - رولات الالمنيوم فويل

3 - رولات تغليف الطبالي

4 - رولات فقاعات

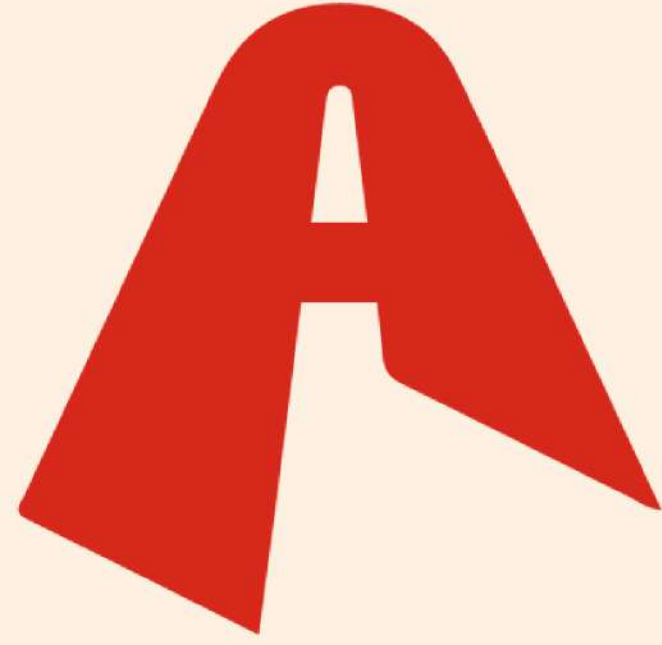

طوانبي ألومنيوم

Disposable Aluminum Trays





AMMON

Imad Sweis Bros. Co.

info@ammonpack.com

Sales: sales@ammonpack.com

Tel: +(962) 6 505 8118

P.O. Box: 340560

Postal Code: 11134

